ADVANTEST[®]
ADVANTEST CORPORATION

TR17301A
Shield Effect Evaluator
Operation Manual

MANUAL NUMBER FOE-8335002A01

Safety Summary

To ensure thorough understanding of all functions and to ensure efficient use of this instrument, please read the manual carefully before using. Note that Advantest bears absolutely no responsibility for the result of operations caused due to incorrect or inappropriate use of this instrument.

If the equipment is used in a manner not specified by Advantest, the protection provided by the equipment may be impaired.

- **Warning Labels**

Warning labels are applied to Advantest products in locations where specific dangers exist. Pay careful attention to these labels during handling. Do not remove or tear these labels. If you have any questions regarding warning labels, please ask your nearest Advantest dealer. Our address and phone number are listed at the end of this manual.

Symbols of those warning labels are shown below together with their meaning.

DANGER: Indicates an imminently hazardous situation which will result in death or serious personal injury.

WARNING: Indicates a potentially hazardous situation which will result in death or serious personal injury.

CAUTION: Indicates a potentially hazardous situation which will result in personal injury or a damage to property including the product.

- **Basic Precautions**

Please observe the following precautions to prevent fire, burn, electric shock, and personal injury.

- Use a power cable rated for the voltage in question. Be sure however to use a power cable conforming to safety standards of your nation when using a product overseas.
- When inserting the plug into the electrical outlet, first turn the power switch OFF and then insert the plug as far as it will go.
- When removing the plug from the electrical outlet, first turn the power switch OFF and then pull it out by gripping the plug. Do not pull on the power cable itself. Make sure your hands are dry at this time.
- Before turning on the power, be sure to check that the supply voltage matches the voltage requirements of the instrument.
- Connect the power cable to a power outlet that is connected to a protected ground terminal. Grounding will be defeated if you use an extension cord which does not include a protected ground terminal.
- Be sure to use fuses rated for the voltage in question.
- Do not use this instrument with the case open.
- Do not place anything on the product and do not apply excessive pressure to the product. Also, do not place flower pots or other containers containing liquid such as chemicals near this

Safety Summary

product.

- When the product has ventilation outlets, do not stick or drop metal or easily flammable objects into the ventilation outlets.
- When using the product on a cart, fix it with belts to avoid its drop.
- When connecting the product to peripheral equipment, turn the power off.

- **Caution Symbols Used Within this Manual**

Symbols indicating items requiring caution which are used in this manual are shown below together with their meaning.

DANGER: Indicates an item where there is a danger of serious personal injury (death or serious injury).

WARNING: Indicates an item relating to personal safety or health.

CAUTION: Indicates an item relating to possible damage to the product or instrument or relating to a restriction on operation.

- **Safety Marks on the Product**

The following safety marks can be found on Advantest products.

 : ATTENTION - Refer to manual.

 : Protective ground (earth) terminal.

 : DANGER - High voltage.

 : CAUTION - Risk of electric shock.

- **Replacing Parts with Limited Life**

The following parts used in the instrument are main parts with limited life.

Replace the parts listed below before their expected lifespan has expired to maintain the performance and function of the instrument.

Note that the estimated lifespan for the parts listed below may be shortened by factors such as the environment where the instrument is stored or used, and how often the instrument is used. The parts inside are not user-replaceable. For a part replacement, please contact the Advantest sales office for servicing.

Each product may use parts with limited life.

For more information, refer to the section in this document where the parts with limited life are described.

Main Parts with Limited Life

Part name	Life
Unit power supply	5 years
Fan motor	5 years
Electrolytic capacitor	5 years
LCD display	6 years
LCD backlight	2.5 years
Floppy disk drive	5 years
Memory backup battery	5 years

- **Hard Disk Mounted Products**

The operational warnings are listed below.

- Do not move, shock and vibrate the product while the power is turned on.
Reading or writing data in the hard disk unit is performed with the memory disk turning at a high speed. It is a very delicate process.
- Store and operate the products under the following environmental conditions.
An area with no sudden temperature changes.
An area away from shock or vibrations.
An area free from moisture, dirt, or dust.
An area away from magnets or an instrument which generates a magnetic field.
- Make back-ups of important data.
The data stored in the disk may become damaged if the product is mishandled. The hard disc has a limited life span which depends on the operational conditions. Note that there is no guarantee for any loss of data.

- **Precautions when Disposing of this Instrument**

When disposing of harmful substances, be sure dispose of them properly with abiding by the state-provided law.

Harmful substances: (1) PCB (polycarbon biphenyl)
(2) Mercury
(3) Ni-Cd (nickel cadmium)
(4) Other
Items possessing cyan, organic phosphorous and hexadic chromium and items which may leak cadmium or arsenic (excluding lead in solder).

Example: fluorescent tubes, batteries

Environmental Conditions

This instrument should only be used in an area which satisfies the following conditions:

- An area free from corrosive gas
- An area away from direct sunlight
- A dust-free area
- An area free from vibrations
- Altitude of up to 2000 m

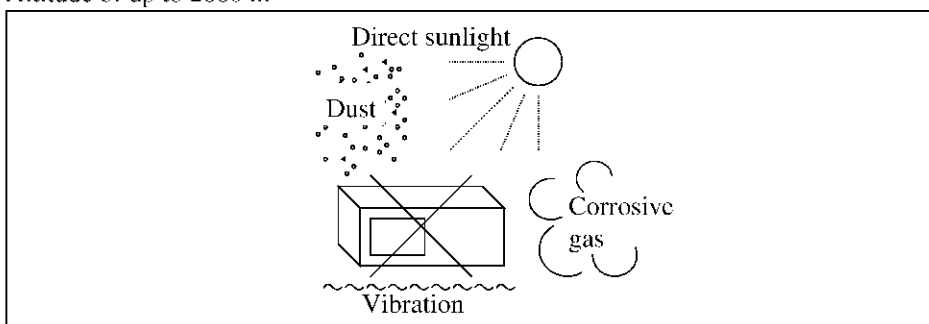

Figure-1 Environmental Conditions

- Operating position

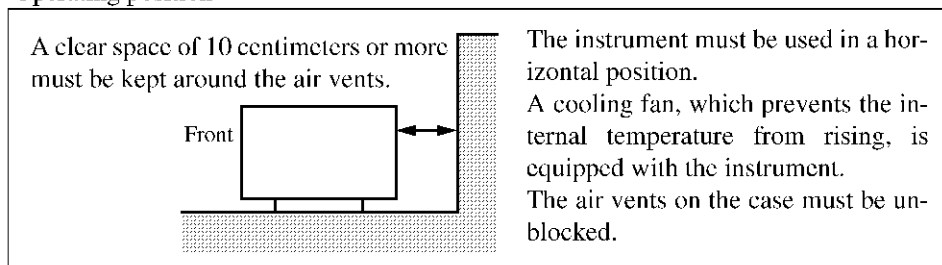

Figure-2 Operating Position

- Storage position

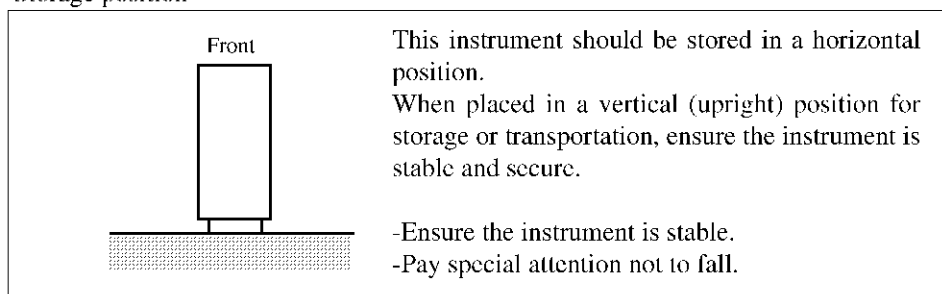

Figure-3 Storage Position



- The classification of the transient over-voltage, which exists typically in the main power supply, and the pollution degree is defined by IEC61010-1 and described below.

Impulse withstand voltage (over-voltage) category II defined by IEC60364-4-443

Pollution Degree 2

Types of Power Cable

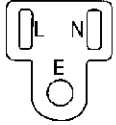
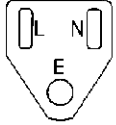
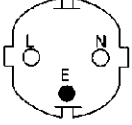
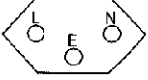
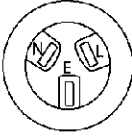
Replace any references to the power cable type, according to the following table, with the appropriate power cable type for your country.

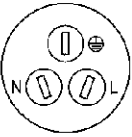
Plug configuration	Standards	Rating, color and length	Model number (Option number)
	PSE: Japan Electrical Appliance and Material Safety Law	125 V at 7 A Black 2 m (6 ft)	Straight: A01402 Angled: A01412
	UL: United States of America CSA: Canada	125 V at 7 A Black 2 m (6 ft)	Straight: A01403 (Option 95) Angled: A01413
	CEE: Europe DEMKO: Denmark NEMKO: Norway VDE: Germany KEMA: The Netherlands CEBEC: Belgium OVE: Austria FIMKO: Finland SEMKO: Sweden	250 V at 6 A Gray 2 m (6 ft)	Straight: A01404 (Option 96) Angled: A01414
	SEV: Switzerland	250 V at 6 A Gray 2 m (6 ft)	Straight: A01405 (Option 97) Angled: A01415
	SAA: Australia, New Zealand	250 V at 6 A Gray 2 m (6 ft)	Straight: A01406 (Option 98) Angled: -----
	BS: United Kingdom	250 V at 6 A Black 2 m (6 ft)	Straight: A01407 (Option 99) Angled: A01417
	CCC: China	250 V at 10 A Black 2 m (6 ft)	Straight: A114009 (Option 94) Angled: A114109

TR17301A
SHIELD EFFECT EVALUATOR
INSTRUCTION MANUAL

Table of Contents

TABLE OF CONTENTS

1. GENERAL	1 - 1
1.1 Outline	1 - 1
1.2 Specifications	1 - 2
1.3 Accessories	1 - 3
2. PRECAUTIONS BEFORE USE	2 - 1
2.1 Outline	2 - 1
2.2 Acceptance Test	2 - 2
2.3 Before Use	2 - 3
2.4 Application Notes	2 - 4
3. MEASUREMENT PROCEDURE	3 - 1
3.1 Mounting the Antenna	3 - 1
3.1.1 Mounting the loop antenna for magnetic field measurement	3 - 1
3.1.2 Mounting the probe antenna for electric field measurement	3 - 3
3.2 Connecting a Spectrum Analyzer to the TR17301A	3 - 4
3.3 Initializing the Spectrum Analyzer	3 - 5
3.4 Inserting the Shield Material	3 - 9

TR17301A
SHIELD EFFECT EVALUATOR
INSTRUCTION MANUAL

List of Figures

LIST OF FIGURES

No.	Title	Page
2 - 1	Replacing the metal screen	2 - 4
3 - 1	Mounting the loop antenna	3 - 1
3 - 2	Mounting angle of loop antennas	3 - 2
3 - 3	Fixing the loop antenna	3 - 2
3 - 4	Mounting the probe antennas	3 - 3
3 - 5	Connecting a spectrum analyzer to the TR17301A	3 - 4
3 - 6	Setting the display line	3 - 7
3 - 7	Waveforms if loop antennas I are mounted correctly	3 - 7
3 - 8	Waveforms if loop antennas I are mounted in the reverse direction	3 - 8
3 - 9	Example of electric field shielding effect (if the test piece is well grounded)	3 - 9
3 - 10	Example of electric field shielding effect (if the test piece is poorly grounded)	3 - 10

TR17301A
SHIELD EFFECT EVALUATOR
INSTRUCTION MANUAL

1.1 Outline

1. GENERAL

1.1 Outline

The TR17301A shield effect evaluator has been developed to generate up to 1,000 MHz of low- or high-impedance magnetic fields and to measure and evaluate the magnetic and electrical shielding effect of plastic shielding materials.

Generally, electromagnetic waves are taken to those plane (electromagnetic) waves that can be detected at a distance from the radiation source that is considerable greater than the wavelength. To measure the accurate shielding effect against such radiation, it is required to have the distance to the shielding material test piece that is sufficiently great in accordance with the wavelength. Therefore, it is extremely difficult to perform such measurement at frequencies in the VHF band or below.

The TR17301A shield effect evaluator uses equivalent low- and high-impedance field sources from a low-impedance microloop and high-impedance electrode respectively. The evaluator places the test piece in the low-impedance magnetic field or high-impedance electric field that can be generated in a distance very close to the electric source. It can evaluate the shielding effect against the magnetic and electric fields.

TR17301A
SHIELD EFFECT EVALUATOR
INSTRUCTION MANUAL

1.2 Specifications

1.2 Specifications

Frequency range:

Electrode I

10 MHz to 1000 MHz microloop coil (loop antenna I)

10 MHz to 1000 MHz electric probe (probe antenna I)

Electrode II

1 MHz to 100 MHz microloop coil (loop antenna II)

1 MHz to 100 MHz electric probe (probe antenna II)

Electrode III

100 kHz to 1 MHz microloop coil (loop antenna III)

Electrode IV

10 kHz to 100 kHz microloop coil (loop antenna IV)

Dimensions of test piece:

200 mm \pm 1 mm by 200 mm \pm 1 mm square

150 mm \pm 1 mm by 150 mm \pm 1 mm square

5 mm thick or less

I/O terminal: BNC

External dimensions:

Approximately 442W x 390H x 339D mm

Weight: 18 kg or less

TR17301A
SHIELD EFFECT EVALUATOR
INSTRUCTION MANUAL

1.3 Accessories

1.3 Accessories

The following lists the standard system accessories. You should check the accessories and their quantity.

Product name		Quantity
(1) High-frequency magnetic field antenna	Loop antenna I	2
(2) Low-frequency magnetic field antenna	Loop antenna II	2
(3) Low-frequency magnetic field antenna	Loop antenna III	2
(4) Low-frequency magnetic field antenna	Loop antenna IV	2
(5) High-frequency electric field antenna	Probe antenna I	2
(6) Low-frequency electric field antenna	Probe antenna II	2
(7) Ground connector		2
(8) 150 x 150-mm test piece adapter		1
(9) Input signal cable	MI-09	2
(10) Hexagonal socket wrench	M4	1
(11) Instruction manual		1

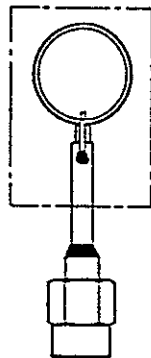

LOOP ANT I

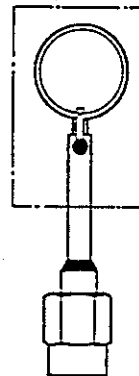

LOOP ANT II

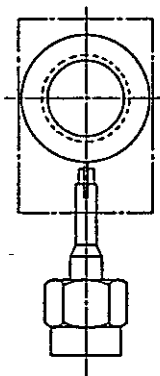

LOOP ANT III

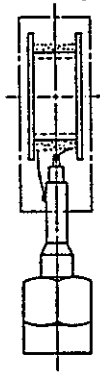

LOOP ANT IV

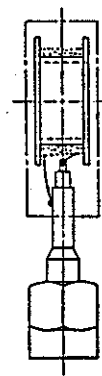
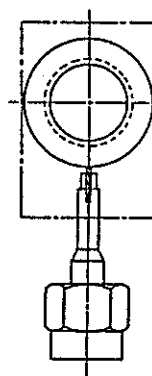

TR17301A
SHIELD EFFECT EVALUATOR
INSTRUCTION MANUAL

1.3 Accessories

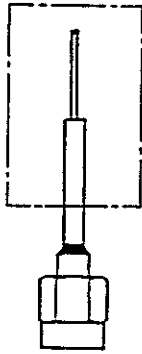

PROBE ANT I

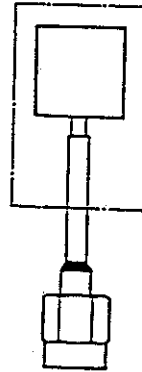

PROBE ANT II



TR17301A
SHIELD EFFECT EVALUATOR
INSTRUCTION MANUAL

2.1 Outline

2. PRECAUTIONS BEFORE USE

2.1 Outline

This chapter explains the operation before use, precautions before, during, and after use, and the system storage and other handling procedure.

The user must read this chapter to use your system correctly.

TR17301A
SHIELD EFFECT EVALUATOR
INSTRUCTION MANUAL

2.2 Acceptance Test

2.2 Acceptance Test

When receiving the TR17301A shield effect evaluator, the user must make sure that it has not been damaged during transportation. If it has been damaged or if it does not operate as defined on the specifications, contact to your service representative for technical support.

The authorized service representatives are listed at the end of this manual.

TR17301A
SHIELD EFFECT EVALUATOR
INSTRUCTION MANUAL

2.3 Before Use

2.3 Before Use

- (1) Four sides of the test piece measured must have been grounded to the evaluator. The test piece must be cut to have an accurate square.
- (2) The ground impedance must be set below the internal impedance of the test piece (that is, the ground resistance must be minimized). The metal fibers inside the test piece must be extruded from the cut face. If they are coated with the conductive layers, the ground impedance can be minimized.
When the ground connector is used, the ground impedance can be minimized. It is useful in the frequency above 100 MHz.

TR17301A
SHIELD EFFECT EVALUATOR
INSTRUCTION MANUAL

2.4 Application Notes

2.4 Application Notes

If the TR17301A shield effect evaluator is not used for a long time, the ground spring and the contact area to the test piece may be rusted. Wipe and clean them with a cloth dipped in the alcohol.

When the evaluator is used for a long time, the metal screen for grounding may be pressed and damaged (similar to the 20 cm or 15 cm adapter).

Loosen the bolts from the metal screen by using the hexagonal wrench of the accessory kit (see Figure 2-1), and replace the metal screen.

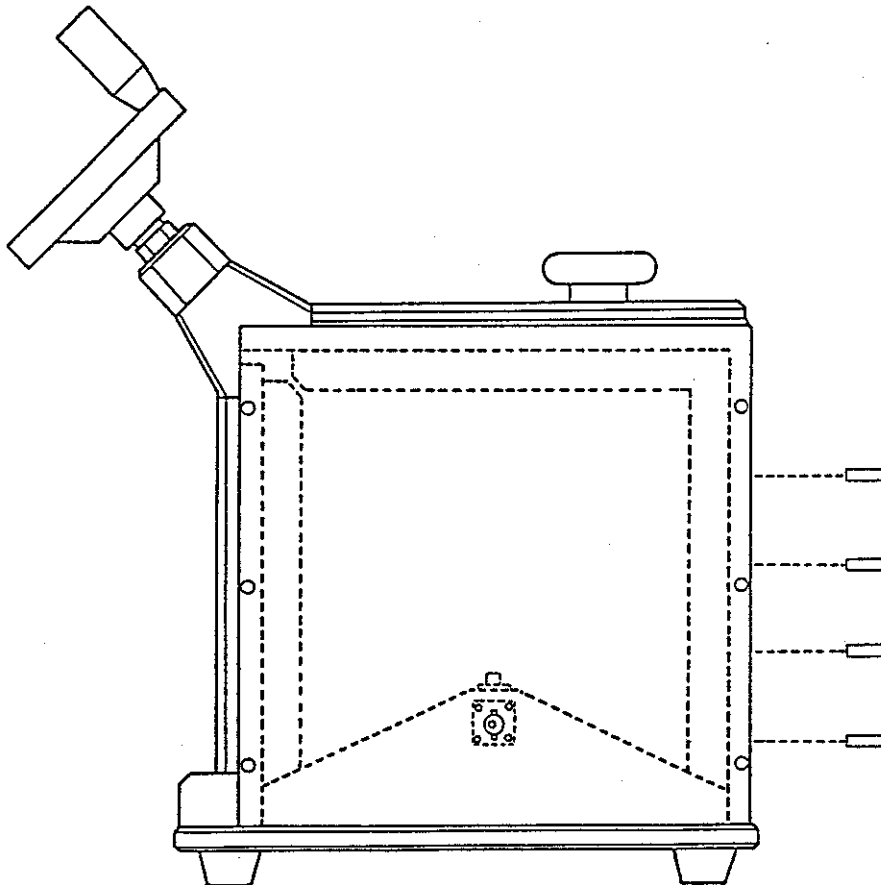

Figure 2-1 Replacing the metal screen

TR17301A
SHIELD EFFECT EVALUATOR
INSTRUCTION MANUAL

3.1 Mounting the Antenna

3. MEASUREMENT PROCEDURE

3.1 Mounting the Antenna

Select an appropriate one from six antennas and mount it. Select the loop antenna for magnetic field measurement, and select the probe antenna for electric field measurement.

The measurement frequency of loop and probe antennas is:

Antenna I: 10 MHz to 1000 MHz

Antenna II: 1 MHz to 100 MHz

Both antennas can be used for the low frequency between 10 MHz to 100 MHz. However, the low-frequency antenna II allows more accurate measurement.

The measurement frequency of magnetic field loop antennas III and IV is:

Antenna III: 100 kHz to 1 MHz

Antenna IV: 10 kHz to 100 kHz

3.1.1 Mounting the loop antenna for magnetic field measurement

As shown in Figure 3-1, mount the loop antenna and tighten the nut at the base of the loop antenna to connect it to the TR17301A.

Caution: Tighten the nut by your fingers. If the nut is tighten using a wrench, the connector may be damaged.

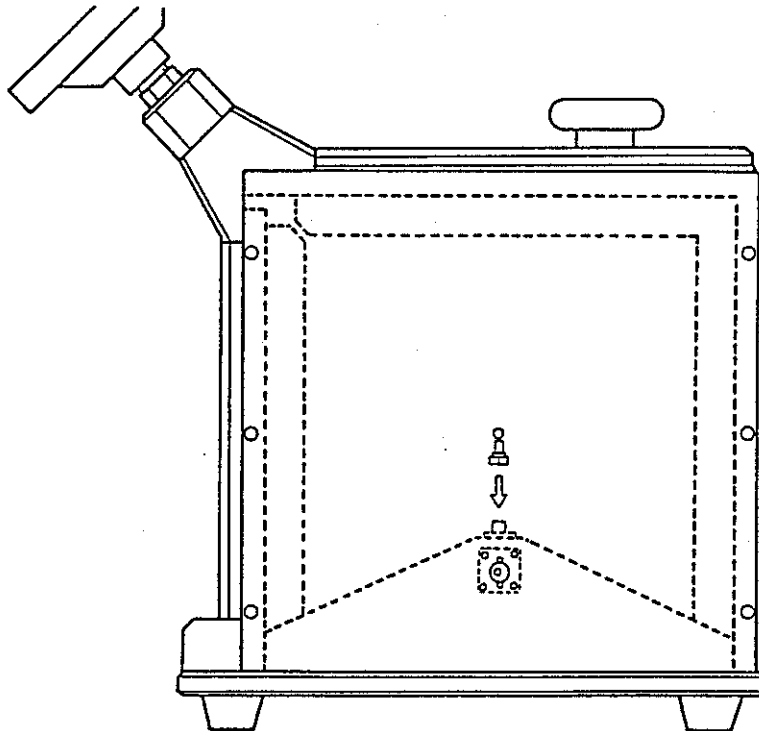

Figure 3-1 Mounting the loop antenna

TR17301A
SHIELD EFFECT EVALUATOR
INSTRUCTION MANUAL

3.1 Mounting the Antenna

The loop antenna I has a spiral form. Mount two antennas so that they have the same spiral direction and that the antenna loops locates in a straight line when viewed from the top (see Figure 3-2).

Hold the base of antenna by a single hand, and tighten the nut by the other hand as shown in Figure 3-3. The antenna can be fixed to keep the fixed loop direction.

Loop antennas II, III, and IV must be mounted so that the short side of rectangle portions faces to each other. For loop antennas II, III, and IV, the internal spiral direction needs not match each other.

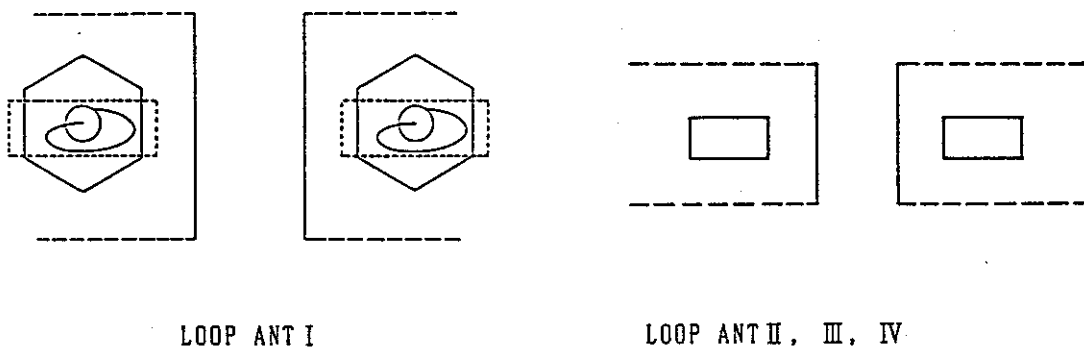

LOOP ANT I

LOOP ANT II, III, IV

Figure 3-2 Mounting angle of loop antennas

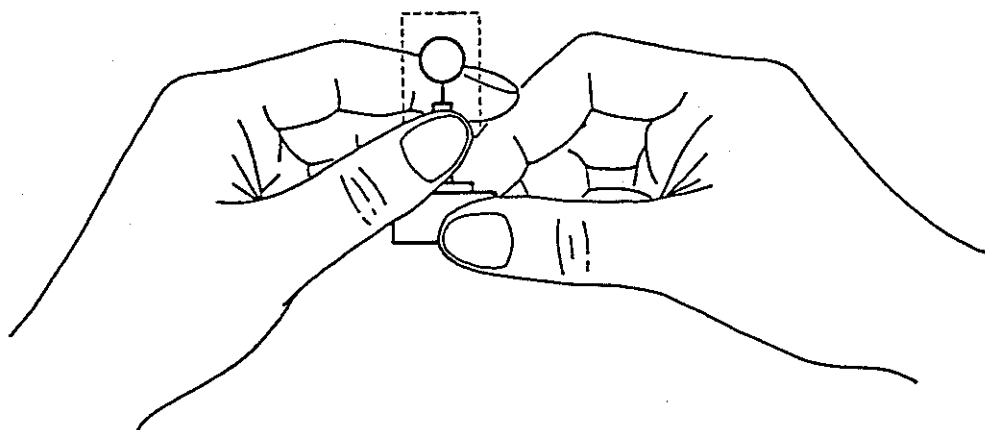

Figure 3-3 Fixing the loop antenna

TR17301A
SHIELD EFFECT EVALUATOR
INSTRUCTION MANUAL

3.1 Mounting the Antenna

3.1.2 Mounting the probe antenna for electric field measurement

Similar to the probe antenna, the base nut must be tightened by your fingers to mount the probe antenna for electric field measurement. The antennas must face each other as shown in Figure 3-4. The evaluator has been fine adjusted before delivery so that the distance between probes becomes $1\text{ cm } \begin{smallmatrix} +6 \\ -1 \end{smallmatrix} \text{ mm}$ when the antennas are mounted correctly.

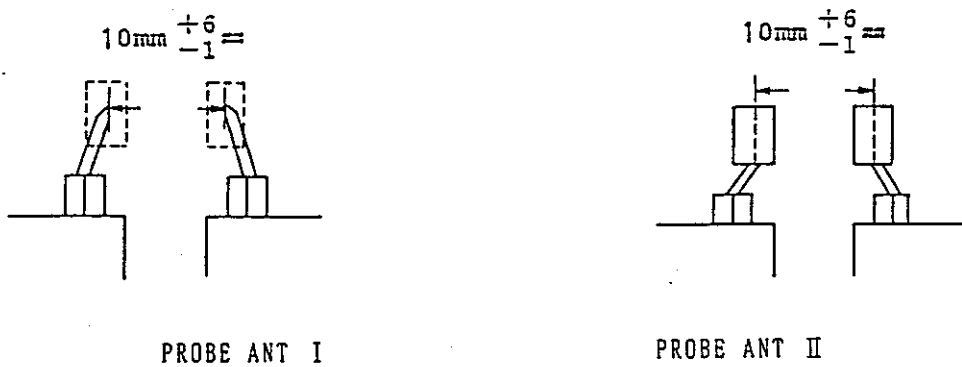

Figure 3-4 Mounting the probe antennas

TR17301A
SHIELD EFFECT EVALUATOR
INSTRUCTION MANUAL

3.2 Connecting a Spectrum Analyzer to the TR17301A

3.2 Connecting a Spectrum Analyzer to the TR17301A

Connect a spectrum analyzer having the tracking generator to the TR17301A shield effect evaluator.

Use the MI-09 cable of the accessory kit to connect the input and output terminals of the TR17301A to the respective input and output terminals of the tracking generator. Two connector cables must be separated from each other to prevent a signal leakage from the cables (see Figure 3-5).

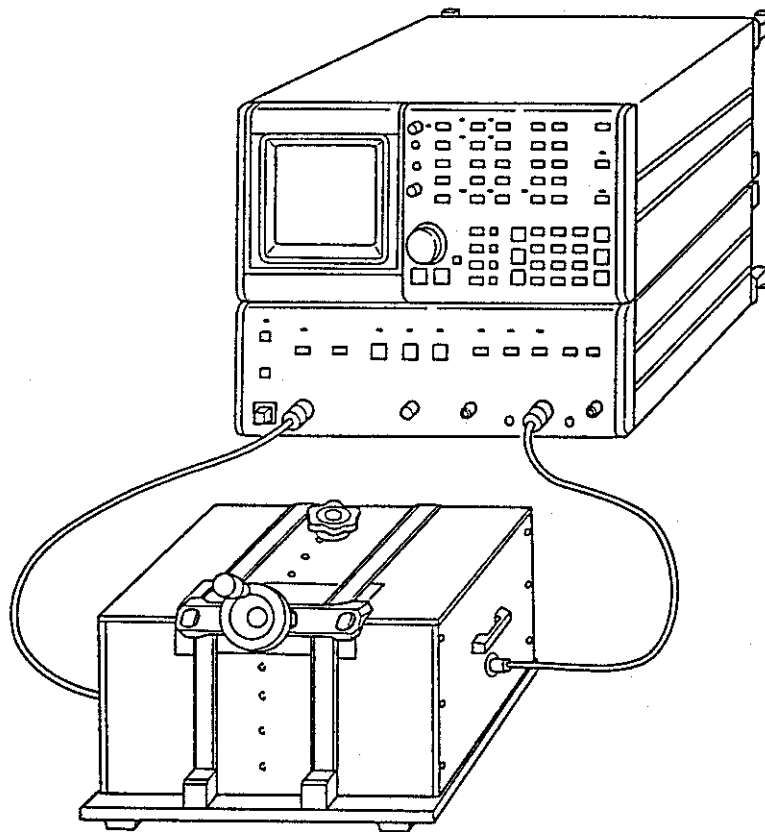

Figure 3-5 Connecting a spectrum analyzer to the TR17301A

TR17301A
SHIELD EFFECT EVALUATOR
INSTRUCTION MANUAL

3.3 Initializing the Spectrum Analyzer

3.3 Initializing the Spectrum Analyzer

(1) After the spectrum analyzer has been connected to the TR17301A, fully close the moving wall of the TR17301A without inserting an evaluation test piece. You must initialize the spectrum analyzer. The following shows the standard initializing procedure that should be followed when the TR4172 Advantest spectrum analyzer is used.

(2) Turn the TR4172 power supply on, press the and (T.G.LEVEL) keys to set the TG attenuator to the variable setup mode, and press the key to set the attenuator to 0 dB. Then, press the (INPUT ATT.) and keys to set the attenuator to 0 dB.

(3) Set the measurement frequency range according to the mounted antenna as follows:

- For Antenna I (10 MHz to 1000 MHz)

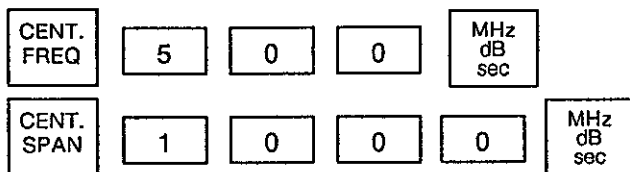

Press these keys in this order. The center frequency will be set to 500 MHz and the frequency span will be set to 1000 MHz. 0 MHz will be displayed at the leftmost end of the screen, and 1000 MHz will be displayed at its rightmost end.

When mounting the grounding adapter (antenna connector adapter), mount it from the most beginning (see Section 3.4 for the standard mounting procedure).

- For antenna II (1 MHz to 100 MHz)
Set the center frequency to 50 MHz and the frequency span to 100 MHz in the similar way.
- For antenna III (100 kHz to 1 MHz)
Set the center frequency to 500 kHz and the frequency span to 1 MHz in the similar way.
- For antenna IV (10 kHz to 100 kHz)
Set the center frequency to 50 kHz and the frequency span to 100 kHz in the similar way. (For antenna IV, it is assumed that the tracking generator has the 10 kHz output on the TR4171 Advantest spectrum analyzer.)

TR17301A
SHIELD EFFECT EVALUATOR
INSTRUCTION MANUAL

3.3 Initializing the Spectrum Analyzer

- (4) Press the , 1 , and kHz + dBm msec keys in this order to set the RES. BW value to 1 kHz. It indicates the signal selectability of the spectrum analyzer. The floor noise is determined by the heat noise of the 50-ohm input resistance and the NF filter width of the circuit of the spectrum analyzer. When the RES. BW value is set to narrow, the floor noise decreases.

The narrow band width allows you to set the wide dynamic range during shielding effect measurement. However, you can measure the shielding effect in that narrow bandwidth only. You must set the longer speed time on the spectrum analyzer.

For shielding effect measurement using the TR17301A, the RES. BW value should be set to 1 kHz and the sweep time should be set within 1 second to 10 seconds. Approximately 50 dB of measuring dynamic range can be set within the frequency range of 100 MHz to 1000 MHz.

- (5) On the TR4172, the sweep time increases automatically when the RES. BW value is reduced. However, the sweep time may increase excessively for shielding effect measurement. Press the SWEEP TIME key to select the manual input mode, and set the sweep time within 1 to 10 seconds. The UNCAL message may be displayed on the screen. The response error may be approximately 1 to 2 dB. The UNCAL message is output during 0.1 dB response error.

When selecting the dynamic range greater than 50 dB, decrease the RES. BW value from 100 Hz to 10 Hz, and increase the sweep time.

When the low-frequency antenna is used, the frequency sweep width is small. The RBW value can be reduced by adjusting the sweep time at the same response error.

Example: Sweep time of antenna II: 1 second
RBW: 100 Hz
Span: 100 MHz

As the RBW value is small, adjust the TG FREQ ADJ control on the TR4172 front panel to set the maximum level.

- (6) Press the DISPLAY LINE key to show the display line on the screen. Locate the display line above the on-screen waves for 6 dB or more by using the step key and data knob.

The waveforms must be normalized on the display line, and the shielding effect of the material must be measured based on the display line. The display line should locate at the top of the screen or at the level 10 dB below the top for easy measurement.

TR17301A
SHIELD EFFECT EVALUATOR
INSTRUCTION MANUAL

3.3 Initializing the Spectrum Analyzer

Figure 3-6 shows an example where the display line is set to the top of the screen.

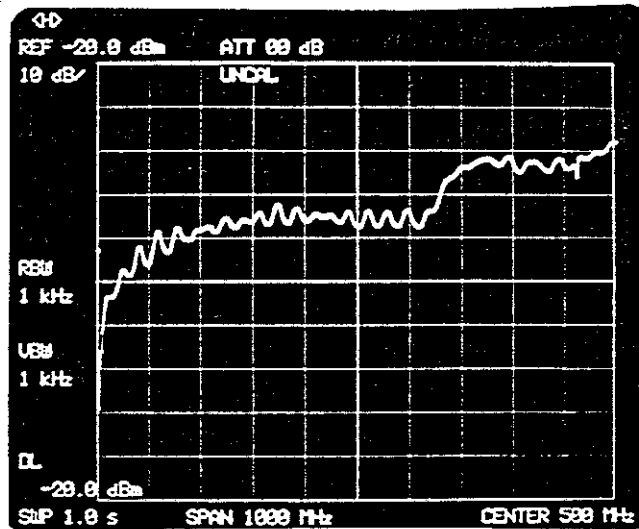

Figure 3-6 Setting the display line

- (7) When the loop antennas are mounted correctly to have the same spiral direction (as shown in Figure 3-2), the waveforms shown in Figure 3-7 will be displayed.
If the antennas are mounted in the reverse direction, separate dots of waveforms (shown in Figure 3-8) may be displayed.

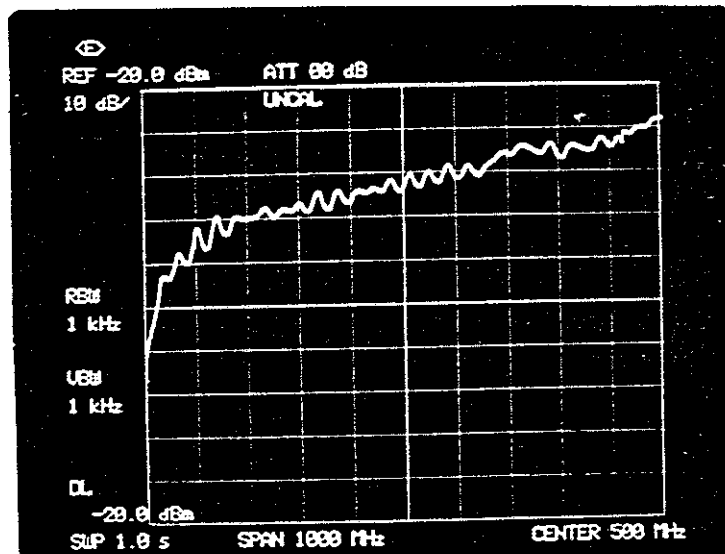

Figure 3-7 Waveforms if loop antennas I are mounted correctly

TR17301A
SHIELD EFFECT EVALUATOR
INSTRUCTION MANUAL

3.3 Initializing the Spectrum Analyzer

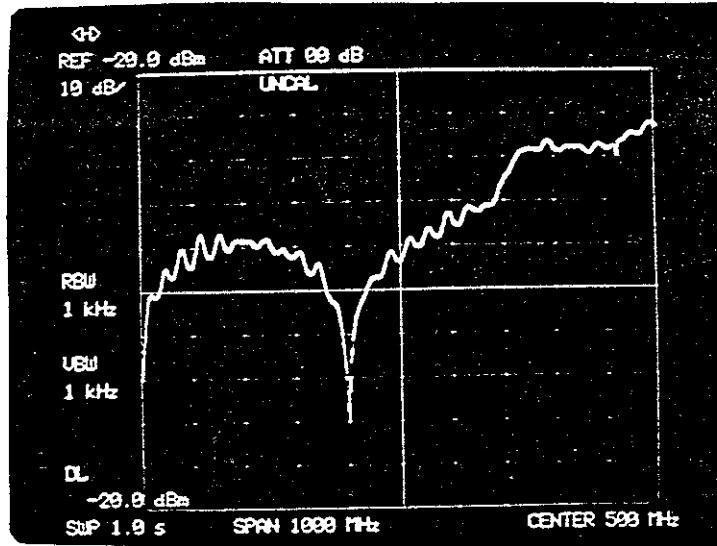

Figure 3-8 Waveforms if loop antennas I are mounted in the reverse direction

- (8) When the display line has been set, press the and keys in this order. The waveforms will be normalized and overlapped on the display line.
- SHIFT
- MHz
dB
sec

TR17301A
SHIELD EFFECT EVALUATOR
INSTRUCTION MANUAL

3.4 Inserting the Shield Material

3.4 Inserting the Shield Material

- (1) When the initialization and normalization are complete on the spectrum analyzer, a plastic shielding material can be inserted for measurement.
- (2) Release the lock at the top of the TR17301A by rotating the handle lever, rotate the handle base clockwise, and open the moving cover toward you.
- (3) Insert the shielding material from the top to bottom, close the moving cover, and lock the handle base.
- (4) Rotate the handle lever counterclockwise and lock the moving cover. The test piece (plastic shielding material) has been fixed.
- (5) The distance between the display line and waveforms on the screen indicates the shielding effect. In the example shown in Figure 3-9, the display line (-20.0 dBm) locates at the top of the screen. The distance between the top of the screen and the waveforms is the shielding effects of the material.
- (6) Figure 3-10 gives a measurement example where the test piece is poor grounded. In such case, follow the instructions given in Section 2.3 and ground the test piece securely.
- (7) Use the grounding adapter (antenna connector adapter) for poor grounding. Face the springs each other, and insert two adapters between the antenna and the evaluator. The springs will contact to the test piece, and the shield line will contact to the antenna connector.

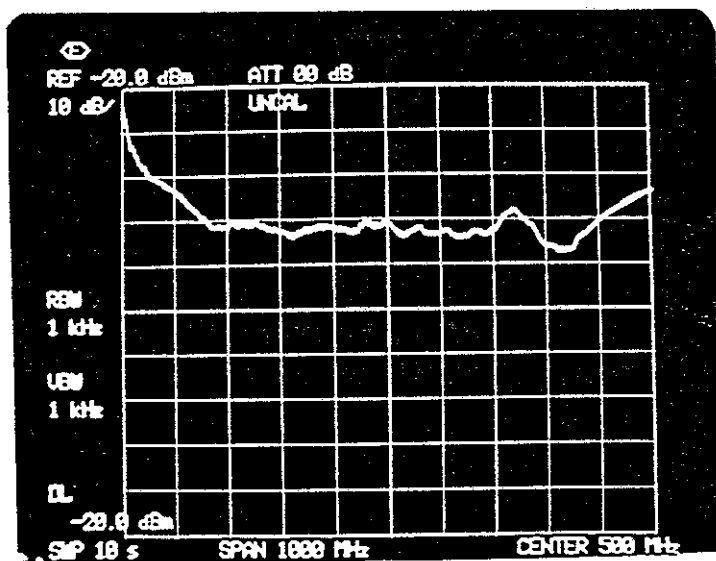

Figure 3-9 Example of electric field shielding effect
(if the test piece is well grounded)

TR17301A
SHIELD EFFECT EVALUATOR
INSTRUCTION MANUAL

3.4 Inserting the Shield Material

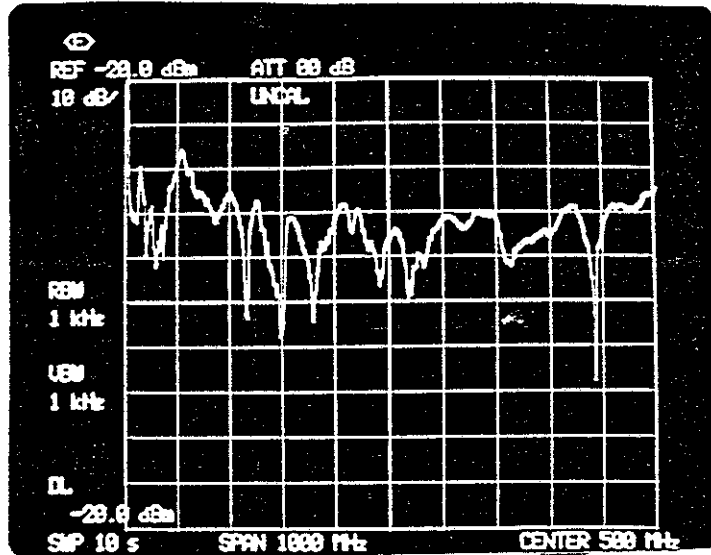

Figure 3-10 Example of electric field shielding effect
(if the test piece is poorly grounded)

- (8) If the noise appears on the waveforms, reduce the noise level by using the TR4172 averaging function.

Press the keys in this order, and averaging will be executed 128 times.

To reduce the number of averaging times and reduce the measurement time, enter an integer multiplied by the square of 2 from the numeric key pad, and press the unit key. The averaging will be executed for the specified number of times.

(For example, press the 8 Hz -dBm sec keys in this order.)

Before changing the center frequency or RES. BW value or before replacing the test piece, press the keys in this order to set the averaging mode to OFF. For the operation details, see the TR4172 operation manual.

- (9) When changing the antennas and repeating measurement, set the averaging mode to OFF. Press the keys to cancel the normalizing mode. Then, restart measurement.

- (10) The TR4172 spectrum analyzer has been used in the measurement example shown above. When using a spectrum analyzer (or tracking scope) that does not have the display line and normalize functions, the waveforms before the test piece is inserted (shown in Figure 3-6) must be used as the reference level. The difference between the reference and the signal level after test piece insertion must be measured and the shielding effect must be evaluated. The on-screen waveforms should be taken by a camera for accurate measurement.

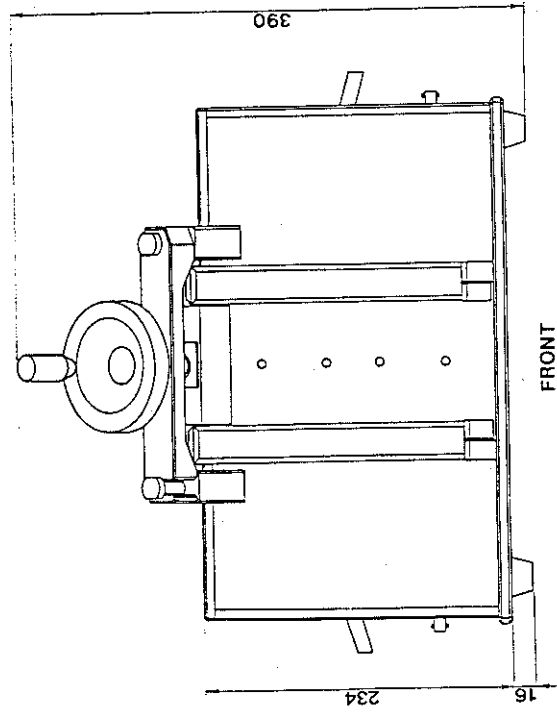
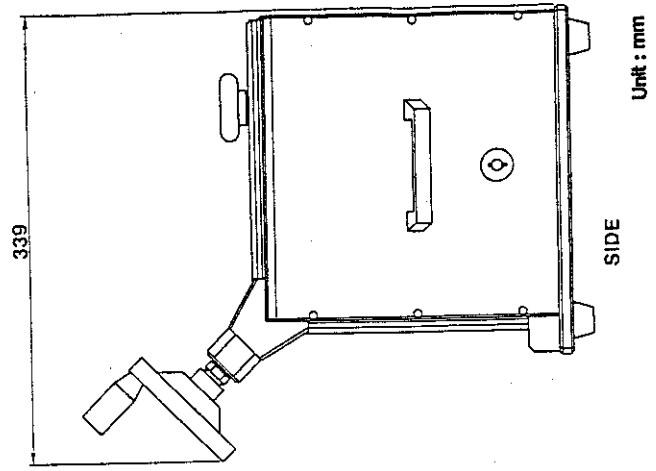
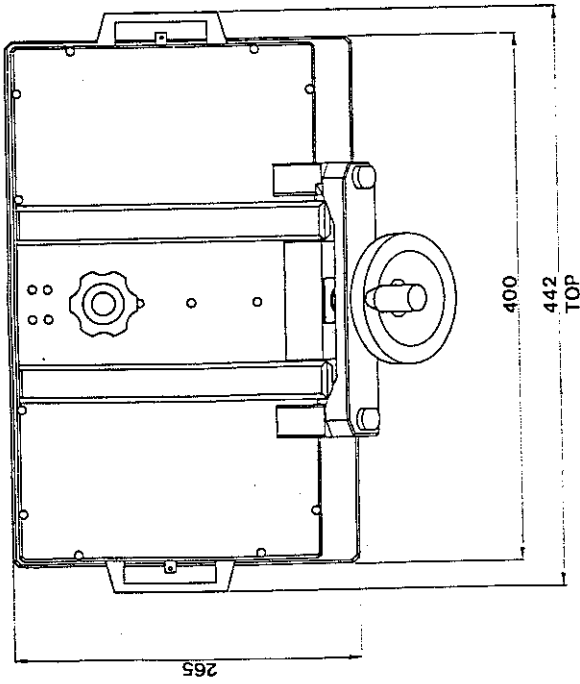

TR17301A
EXTERNAL VIEW

R17301AEXT1-8903-A

IMPORTANT INFORMATION FOR ADVANTEST SOFTWARE

PLEASE READ CAREFULLY: This is an important notice for the software defined herein. Computer programs including any additions, modifications and updates thereof, operation manuals, and related materials provided by Advantest (hereafter referred to as "SOFTWARE"), included in or used with hardware produced by Advantest (hereafter referred to as "PRODUCTS").

SOFTWARE License

All rights in and to the SOFTWARE (including, but not limited to, copyright) shall be and remain vested in Advantest. Advantest hereby grants you a license to use the SOFTWARE only on or with Advantest PRODUCTS.

Restrictions

- (1) You may not use the SOFTWARE for any purpose other than for the use of the PRODUCTS.
- (2) You may not copy, modify, or change, all or any part of, the SOFTWARE without permission from Advantest.
- (3) You may not reverse engineer, de-compile, or disassemble, all or any part of, the SOFTWARE.

Liability

Advantest shall have no liability (1) for any PRODUCT failures, which may arise out of any misuse (misuse is deemed to be use of the SOFTWARE for purposes other than its intended use) of the SOFTWARE. (2) For any dispute between you and any third party for any reason whatsoever including, but not limited to, infringement of intellectual property rights.

LIMITED WARRANTY

1. Unless otherwise specifically agreed by Seller and Purchaser in writing, Advantest will warrant to the Purchaser that during the Warranty Period this Product (other than consumables included in the Product) will be free from defects in material and workmanship and shall conform to the specifications set forth in this Operation Manual.
2. The warranty period for the Product (the "Warranty Period") will be a period of one year commencing on the delivery date of the Product.
3. If the Product is found to be defective during the Warranty Period, Advantest will, at its option and in its sole and absolute discretion, either (a) repair the defective Product or part or component thereof or (b) replace the defective Product or part or component thereof, in either case at Advantest's sole cost and expense.
4. This limited warranty will not apply to defects or damage to the Product or any part or component thereof resulting from any of the following:
 - (a) any modifications, maintenance or repairs other than modifications, maintenance or repairs (i) performed by Advantest or (ii) specifically recommended or authorized by Advantest and performed in accordance with Advantest's instructions;
 - (b) any improper or inadequate handling, carriage or storage of the Product by the Purchaser or any third party (other than Advantest or its agents);
 - (c) use of the Product under operating conditions or environments different than those specified in the Operation Manual or recommended by Advantest, including, without limitation, (i) instances where the Product has been subjected to physical stress or electrical voltage exceeding the permissible range and (ii) instances where the corrosion of electrical circuits or other deterioration was accelerated by exposure to corrosive gases or dusty environments;
 - (d) use of the Product in connection with software, interfaces, products or parts other than software, interfaces, products or parts supplied or recommended by Advantest;
 - (e) incorporation in the Product of any parts or components (i) provided by Purchaser or (ii) provided by a third party at the request or direction of Purchaser or due to specifications or designs supplied by Purchaser (including, without limitation, any degradation in performance of such parts or components);
 - (f) Advantest's incorporation or use of any specifications or designs supplied by Purchaser;
 - (g) the occurrence of an event of force majeure, including, without limitation, fire, explosion, geological change, storm, flood, earthquake, tidal wave, lightning or act of war; or
 - (h) any negligent act or omission of the Purchaser or any third party other than Advantest.
5. **EXCEPT TO THE EXTENT EXPRESSLY PROVIDED HEREIN, ADVANTEST HEREBY EXPRESSLY DISCLAIMS, AND THE PURCHASER HEREBY WAIVES, ALL WARRANTIES, WHETHER EXPRESS OR IMPLIED, STATUTORY OR OTHERWISE, INCLUDING, WITHOUT LIMITATION, (A) ANY WARRANTY OF MERCHANTABILITY OR FITNESS FOR A PARTICULAR PURPOSE AND (B) ANY WARRANTY OR REPRESENTATION AS TO THE VALIDITY, SCOPE, EFFECTIVENESS OR USEFULNESS OF ANY TECHNOLOGY OR ANY INVENTION.**
6. **THE REMEDY SET FORTH HEREIN SHALL BE THE SOLE AND EXCLUSIVE REMEDY OF THE PURCHASER FOR BREACH OF WARRANTY WITH RESPECT TO THE PRODUCT.**
7. **ADVANTEST WILL NOT HAVE ANY LIABILITY TO THE PURCHASER FOR ANY INDIRECT, INCIDENTAL, SPECIAL, CONSEQUENTIAL OR PUNITIVE DAMAGES, INCLUDING, WITHOUT LIMITATION, LOSS OF ANTICIPATED PROFITS OR REVENUES, IN ANY AND ALL CIRCUMSTANCES, EVEN IF ADVANTEST HAS BEEN ADVISED OF THE POSSIBILITY OF SUCH DAMAGES AND WHETHER ARISING OUT OF BREACH OF CONTRACT, WARRANTY, TORT (INCLUDING, WITHOUT LIMITATION, NEGLIGENCE), STRICT LIABILITY, INDEMNITY, CONTRIBUTION OR OTHERWISE. TORT (INCLUDING, WITHOUT LIMITATION, NEGLIGENCE), STRICT LIABILITY, INDEMNITY, CONTRIBUTION OR OTHERWISE.**
8. **OTHER THAN THE REMEDY FOR THE BREACH OF WARRANTY SET FORTH HEREIN, ADVANTEST SHALL NOT BE LIABLE FOR, AND HEREBY DISCLAIMS TO THE FULLEST EXTENT PERMITTED BY LAW ANY LIABILITY FOR, DAMAGES FOR PRODUCT FAILURE OR DEFECT, WHETHER ARISING OUT OF BREACH OF CONTRACT, TORT (INCLUDING, WITHOUT LIMITATION, NEGLIGENCE), STRICT LIABILITY, INDEMNITY, CONTRIBUTION OR OTHERWISE.**

CUSTOMER SERVICE DESCRIPTION

In order to maintain safe and trouble-free operation of the Product and to prevent the incurrence of unnecessary costs and expenses, Advantest recommends a regular preventive maintenance program under its maintenance agreement.

Advantest's maintenance agreement provides the Purchaser on-site and off-site maintenance, parts, maintenance machinery, regular inspections, and telephone support and will last a maximum of ten years from the date the delivery of the Product. For specific details of the services provided under the maintenance agreement, please contact the nearest Advantest office listed at the end of this Operation Manual or Advantest's sales representatives.

Some of the components and parts of this Product have a limited operating life (such as, electrical and mechanical parts, fan motors, unit power supply, etc.). Accordingly, these components and parts will have to be replaced on a periodic basis. If the operating life of a component or part has expired and such component or part has not been replaced, there is a possibility that the Product will not perform properly. Additionally, if the operating life of a component or part has expired and continued use of such component or part damages the Product, the Product may not be repairable. Please contact the nearest Advantest office listed at the end of this Operation Manual or Advantest's sales representatives to determine the operating life of a specific component or part, as the operating life may vary depending on various factors such as operating condition and usage environment.

SALES & SUPPORT OFFICES

Advantest Korea Co., Ltd.

22BF, Kyobo KangNam Tower,
1303-22, Seocho-Dong, Seocho-Ku, Seoul #137-070, Korea
Phone: +82-2-532-7071
Fax: +82-2-532-7132

Advantest (Suzhou) Co., Ltd.

Shanghai Branch Office:
Bldg. 6D, NO.1188 Gumei Road, Shanghai, China 201102 P.R.C.
Phone: +86-21-6485-2725
Fax: +86-21-6485-2726

Shanghai Branch Office:
406/F, Ying Building, Quantum Plaza, No. 23 Zhi Chun Road,
Hai Dian District, Beijing,
China 100083
Phone: +86-10-8235-3377
Fax: +86-10-8235-6717

Advantest (Singapore) Pte. Ltd.

438A Alexandra Road, #08-03/06
Alexandra Technopark Singapore 119967
Phone: +65-6274-3100
Fax: +65-6274-4055

Advantest America, Inc.

3201 Scott Boulevard, Suite, Santa Clara, CA 95054, U.S.A
Phone: +1-408-988-7700
Fax: +1-408-987-0691

ROHDE & SCHWARZ Europe GmbH

Mühldorfstraße 15 D-81671 München, Germany
(P.O.B. 80 14 60 D-81614 München, Germany)
Phone: +49-89-4129-13711
Fax: +49-89-4129-13723

ADVANTEST[®]

<http://www.advantest.co.jp>