ADVANTEST®

ADVANTEST CORPORATION

<p>INSTRUCTION MANUAL</p>
<p>TR47252</p>
<p>Personality Kit</p>

MANUAL NUMBER 47252 OEA 606

<p>Before reselling to other corporations or re-exporting to other countries, you are required to obtain permission from both the Japanese Government under its Export Control Act and the U. S. Government under its Export Control Law.</p>

TR47252
PERSONALITY KIT
INSTRUCTION MANUAL

PREFACE

PREFACE

This manual applies to the system disk P47252-001FJ V2.0.

TR47252
PERSONALITY KIT
INSTRUCTION MANUAL

LIST OF EFFECTIVE PAGES

LIST OF EFFECTIVE PAGES

Preface	Preface	Jun 3/86	3 - 7	Jun 3/86
Record of Revisions	R - 1	Jun 3/86	3 - 8	Jun 3/86
List of Effective Pages	P - 1	Jun 3/86	3 - 9	Jun 3/86
List of Related Manuals	M - 1	Jun 3/86	3 - 10	Jun 3/86
Table of Contents	C - 1	Jun 3/86	3 - 11	Jun 3/86
1 - 1		Jun 3/86	3 - 12	Jun 3/86
1 - 2		Jun 3/86	3 - 13	Jun 3/86
1 - 3		Jun 3/86	3 - 14	Jun 3/86
2 - 1		Jun 3/86	4 - 1	Jun 3/86
2 - 2		Jun 3/86	4 - 2	Jun 3/86
2 - 3		Jun 3/86	4 - 3	Jun 3/86
2 - 4		Jun 3/86	4 - 4	Jun 3/86
2 - 5		Jun 3/86	4 - 5	Jun 3/86
2 - 6		Jun 3/86	4 - 6	Jun 3/86
2 - 7		Jun 3/86	4 - 7	Jun 3/86
2 - 8		Jun 3/86	4 - 8	Jun 3/86
2 - 9		Jun 3/86	4 - 9	Jun 3/86
2 - 10		Jun 3/86	5 - 1	Jun 3/86
2 - 11		Jun 3/86	5 - 2	Jun 3/86
2 - 12		Jun 3/86	5 - 3	Jun 3/86
2 - 13		Jun 3/86	5 - 4	Jun 3/86
2 - 14		Jun 3/86	6 - 1	Jun 3/86
2 - 15		Jun 3/86	6 - 2	Jun 3/86
2 - 16		Jun 3/86	7 - 1	Jun 3/86
2 - 17		Jun 3/86	7 - 2	Jun 3/86
2 - 18		Jun 3/86	List of Figures	F - 1 Jun 3/86
2 - 19		Jun 3/86		F - 2 Jun 3/86
2 - 20		Jun 3/86	List of Tables	T - 1 Jun 3/86
2 - 21		Jun 3/86	List of Examples	E - 1 Jun 3/86
2 - 22		Jun 3/86	Alphabetical Index	I - 1 Jun 3/86
2 - 23		Jun 3/86		
2 - 24		Jun 3/86		
2 - 25		Jun 3/86		
3 - 1		Jun 3/86		
3 - 2		Jun 3/86		
3 - 3		Jun 3/86		
3 - 4		Jun 3/86		
3 - 5		Jun 3/86		
3 - 6		Jun 3/86		

Note: Pages with # are revised.
Pages with ## are added.
Pages with () are deleted.

TR47252
PERSONALITY KIT
INSTRUCTION MANUAL

LIST OF RELATED MANUALS

LIST OF RELATED MANUALS

<u>Manual No.</u>	<u>Manual Name</u>	<u>Remarks</u>
TR4725	Logic Analyzer	
TR47250	Personality Kit	
TR47251	Personality Kit	
TR47252	Personality Kit	
TR47241	Personality Kit	
TR47242	Personality Kit	
TR47243	Personality Kit	

TR47252
PERSONALITY KIT
INSTRUCTION MANUAL

TABLE OF CONTENTS

TABLE OF CONTENTS

1. GENERAL INFORMATION	1 - 1
1.1 HOW TO USE THIS INSTRUCTION MANUAL	1 - 1
1.2 TR47252 GENERAL DESCRIPTIONS	1 - 2
1.3 UNPACKING AND INSPECTION	1 - 3
1.3.1 Appearance Check and Component Confirmation	1 - 3
2. MEASUREMENT PREPARATION AND PREPARATORY INFORMATION	2 - 1
2.1 INTRODUCTION	2 - 1
2.2 PERSONALITY BOARD INSTALLATION METHOD	2 - 2
2.3 CONNECTING PROBE AND THE SYSTEM UNDER TEST	2 - 3
2.3.1 Connecting Microprocessor Probe	2 - 3
2.3.2 Connecting Data Acquisition Probe E/F	2 - 6
2.4 USE OF THE MICROPROCESSOR PROBE	2 - 10
2.5 LOADING THE SYSTEM SOFTWARE	2 - 11
2.6 CRT DISPLAY FORMATS AND THEIR MEANINGS	2 - 14
2.7 INPUTTING DATA TO MENU ITEMS	2 - 18
2.8 USE OF HELP KEY	2 - 20
2.9 USER DISK PREPARATION	2 - 24
3. OPERATION EXAMPLES	3 - 1
3.1 INTRODUCTION	3 - 1
3.2 SIMPLE EXAMPLES OF TIMING ANALYSIS	3 - 2
3.3 SIMPLE EXAMPLES OF STATE ANALYSIS	3 - 7
3.4 SIMPLE EXAMPLES OF S & T ANALYSIS	3 - 9
3.5 FLOPPY DISK APPLICATIONS	3 - 10
3.6 USE OF QuickVIEW	3 - 11
3.7 EXAMPLES OF USING THE PROGRAMS	3 - 12
4. PERSONALITY KIT PERFORMANCE CHARACTERISTICS	4 - 1
4.1 INTRODUCTION	4 - 1
4.2 INPUT CHANNEL CONFIGURATION (CONFIG)	4 - 2
4.2.1 CONFIG Menu Screen for 68000/68010 Microprocessor	4 - 2
4.3 SYMBOL AND CODE DEFINITIONS (SYMDEF)	4 - 4
4.3.1 CODE Table for 68000/68010	4 - 4
4.4 DISPLAY OF CAPTURED DATA IN STATE ANALYZER (DISPLAY)	4 - 5
4.4.1 QUEUE Sample Mode Display	4 - 5
4.4.2 BUS Sample Mode Display	4 - 7
4.4.3 68000/68010 Disassembling Format	4 - 8
5. OPERATION CHECK	5 - 1
5.1 MICROPROCESSOR PROBE TEST	5 - 1
5.2 DATA ACQUISITION PROBE E/F TEST	5 - 4
6. EQUIPMENT STORAGE AND TRANSPORTATION PRECAUTIONS	6 - 1
6.1 STORAGE	6 - 1
6.2 TRANSPORTATION	6 - 2
7. SPECIFICATIONS	7 - 1
7.1 TR47252 SPECIFICATIONS	7 - 1

TR47252
PERSONALITY KIT
INSTRUCTION MANUAL

1.1 HOW TO USE THIS INSTRUCTION MANUAL

1. GENERAL INFORMATION

1.1 HOW TO USE THIS INSTRUCTION MANUAL

The ADVANTEST TR4725 Logic Analyzer instruction manual consists of the TR4725 instruction manual (hereafter called the main unit instruction manual) and all of the personality kit instruction manuals (the PK instruction manual).

For beginners of logic analyzer, ADVANTEST recommends reading in the order of Chapter 1 and Chapter 2, Section 2.8 "Panel Descriptions" of the main unit instruction manual and then Chapters 1, 2 and 3 of the PK instruction manual for familiarization of the operating procedures (Chapters 2 and 3 of the main unit instruction manual are not necessary to read.).

TR47252
PERSONALITY KIT
INSTRUCTION MANUAL

1.2 TR47252 GENERAL DESCRIPTIONS

1.2 TR47252 GENERAL DESCRIPTIONS

The TR47252 68000/68010 Personality Kit is the plug-in probe for state analysis used by installing in the TR4725 Logic Analyzer main unit. The major features of this personality kit are as follows:

- (1) Analysis can be easily performed even with complicated prefetching since the hardware emulates the queue in the 68000/68010 CPU.
- (2) State analysis has been expedited since 68000/68010 mnemonic is also available, along with numeric values, for analysis of the captured data.
- (3) Data capturing is assigned to special hardware, thus high accuracy analysis can be performed with a smaller probe.
- (4) State analysis efficiency has been upgraded since symbols and codes are defined and provided for setting measuring conditions or analyzing measured data.
- (5) Complicated applications are enabled by more than one trace window condition and memory fragmentation for setting trace conditions.
- (6) Measurement labor-saving, standardization, and automation have been achieved by the application of high performance user interface, such as the use of the interactive menu procedure and the simple-to-use disk operation.
- (7) The major system software provided with the system disk attached to the personality kit ensures the upgrading of the performance functions along with the system disk updated revision.

TR47252
PERSONALITY KIT
INSTRUCTION MANUAL

1.3 UNPACKING AND INSPECTION

1.3 UNPACKING AND INSPECTION

1.3.1 Appearance Check and Component Confirmation

Upon receiving the TR47252 Personality Kit, inspect the product appearance to check for any damage caused by transportation.

Next, check the component quantity and ratings according to the following list. If any inadequacy or defect or damage is found, contact your nearest ADVANTEST representative. The addresses and telephone numbers are listed at the end of this manual.

Item name	Model name	Q'ty
Personality board		2
Microprocessor probe	TR14725-20	1
64-pin DIP clip cable	A04725-21	1
64-pin DIP plug cable	A04725-22	1
Probe test adapter		1
64-pin DIP IC package		1
System software package	P47252-001FJ	2
Blank disk	MF-2DD	2
Disk storage case		1
Miscellaneous container		1
Personality kit storage case		1
Instruction manual	E47252	1

* The blank disk can be purchased separately.
Model name: A09502 (a set of ten disks)

MEMO



A large, empty rectangular area with rounded corners, enclosed by a thin black border, intended for writing the memo's content.

TR47252
PERSONALITY KIT
INSTRUCTION MANUAL

2.1 INTRODUCTION

2. MEASUREMENT PREPARATION AND PREPARATORY INFORMATION

2.1 INTRODUCTION

Be sure to read this chapter if using this probe for the first time. This chapter describes the operations preparatory to measurement and the necessary preparatory information. The description is constructed so that the reader can understand the contents of it while actually operating the probe. Therefore, place the probe within reach when reading this manual for operation.

TR47252
PERSONALITY KIT
INSTRUCTION MANUAL

2.2 PERSONALITY BOARD INSTALLATION METHOD

2.2 PERSONALITY BOARD INSTALLATION METHOD

Follow the following procedures for installing the personality board.
(The personality board is not installed in the TR4725 main unit when shipped.)

- (1) Check that the power is turned OFF.
- (2) Remove the four machine screws (3mm;+) from the main unit cover and remove the upper cover.
- (3) When an other personality board is already installed, remove it. Markers "1" and "2" are affixed on the personality board slot (refer to Figure 2-1).
- (4) Install the personality board with marker "1" on the board ejector into the slot "1".
- (5) Install the personality board with marker "2" on the board ejector into the slot "2". Then, connect the 50-pin flat cable to the connector in the center of the board.
- (6) Mount the four machine screws to re-set the upper cover.

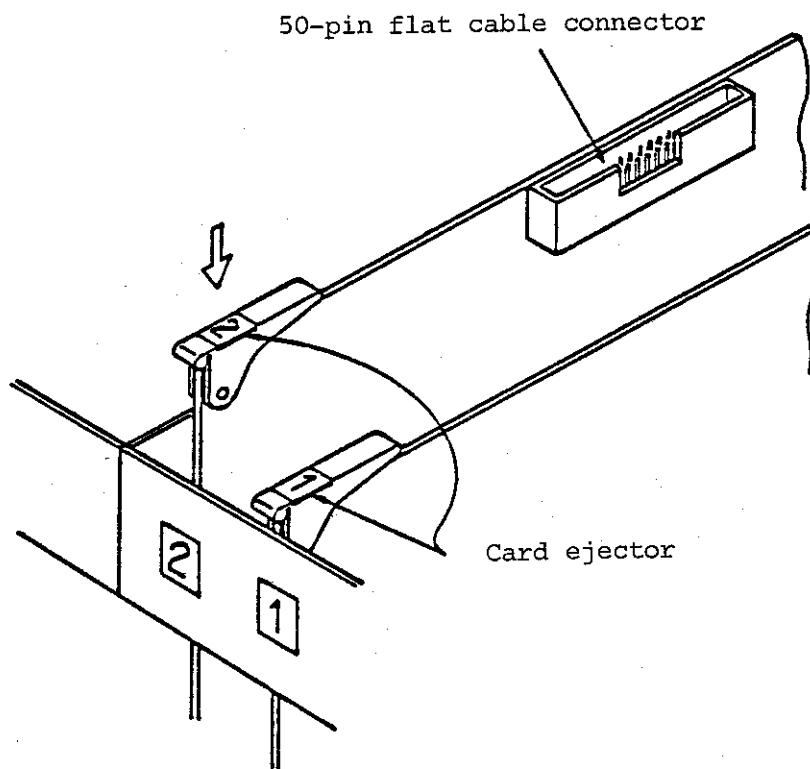

Figure 2-1 Personality Board Installation Method

TR47252
PERSONALITY KIT
INSTRUCTION MANUAL

2.3 CONNECTING PROBE AND THE SYSTEM UNDER TEST

2.3 CONNECTING PROBE AND THE SYSTEM UNDER TEST

Perform the following procedures to connect probe to the system to be measured using 68000/68010:

2.3.1 Connecting Microprocessor Probe

This personality kit contains a microprocessor probe (TR14725-20) for connecting a system under test (termed SUT hereafter) in which a microprocessor 68000 or 68010 is used. This section describes the actual connecting method of the probe. For how to handle the data captured by the probe, see Section 4.2.1.

Figure 2-2 shows the shape and parts names of the microprocessor probe.

(1) Connecting the microprocessor probe to the main unit

Three connectors with the name plates "B", "C" and "D" are provided at the cable end of the microprocessor probe (TR14725-20). Insert respectively the three connectors to the probe slots in the main unit rear panel. The connectors can be locked by screws.

CAUTION

Before connecting microprocessor probe, make sure to turn OFF the power of the main unit.

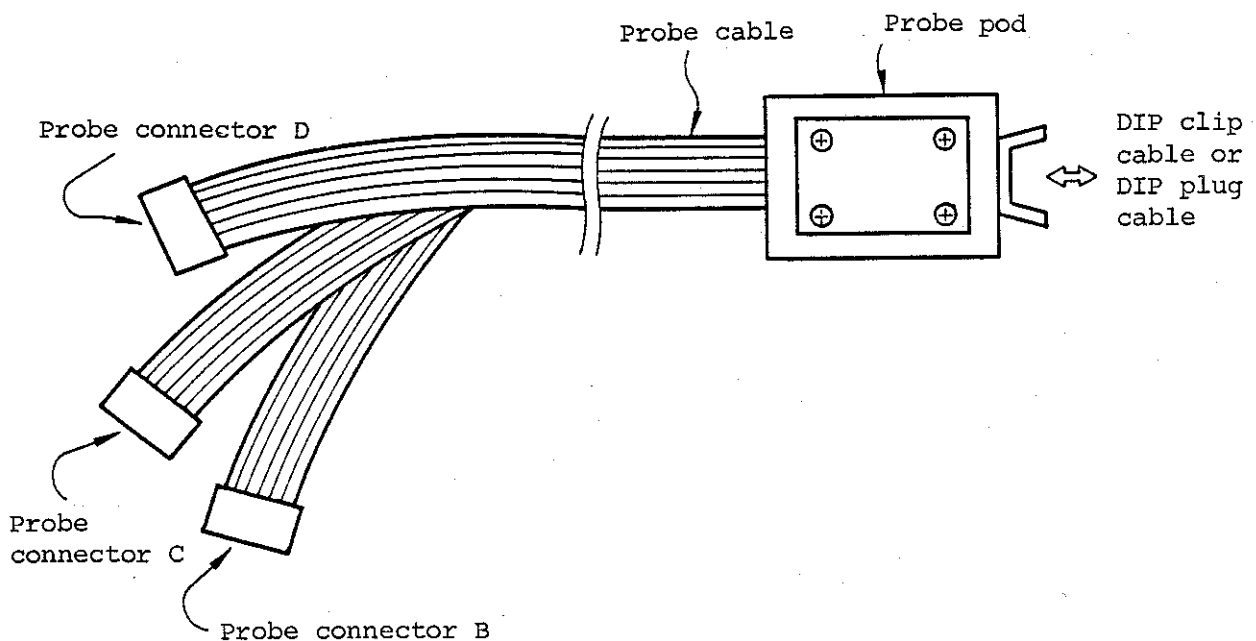

Figure 2-2 Microprocessor Probe Shape and Parts Names

TR47252
PERSONALITY KIT
INSTRUCTION MANUAL

2.3 CONNECTING PROBE AND THE SYSTEM UNDER TEST

(2) Connecting the microprocessor probe and SUT

There are two procedures to connect the microprocessor probe to the SUT (System Under Test): by using DIP clip cable or DIP plug cable. These are illustrated respectively in Figures 2-3 and 2-4.

Either procedure is applicable when the target microprocessor uses a socket. Only DIP clip cable is applicable when soldering is used for the target microprocessor. The connecting must be performed without mistaking pin 1 position no matter which procedure is adopted.

TR47252
PERSONALITY KIT
INSTRUCTION MANUAL

2.3 CONNECTING PROBE AND THE SYSTEM UNDER TEST

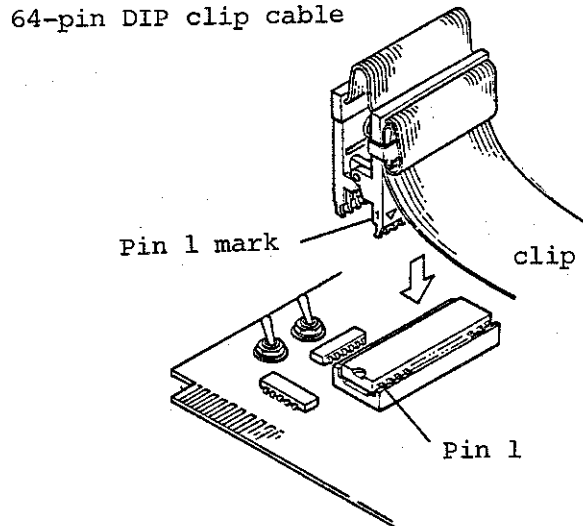

Figure 2-3 The Use of DIP Clip Cable

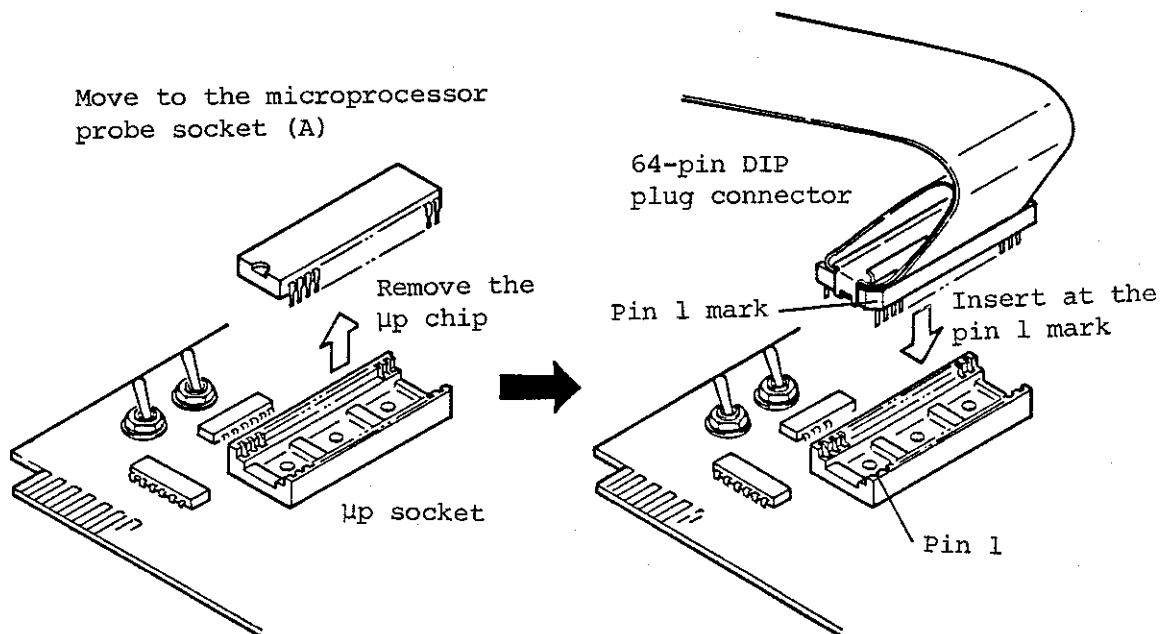

Figure 2-4 The Use of DIP Plug Cable

TR47252
PERSONALITY KIT
INSTRUCTION MANUAL

2.3 CONNECTING PROBE AND THE SYSTEM UNDER TEST

2.3.2 Connecting Data Acquisition Probe E/F

Two probes, data acquisition probe E (TR14702-01; hereafter called probe E) and data acquisition probe F (TR14702-02; hereafter called probe F), are used to capture data from the system under test (hereafter called SUT). Each probe can capture signals of eight channels. The shapes and parts names of probe E/F are shown in Figure 2-5.

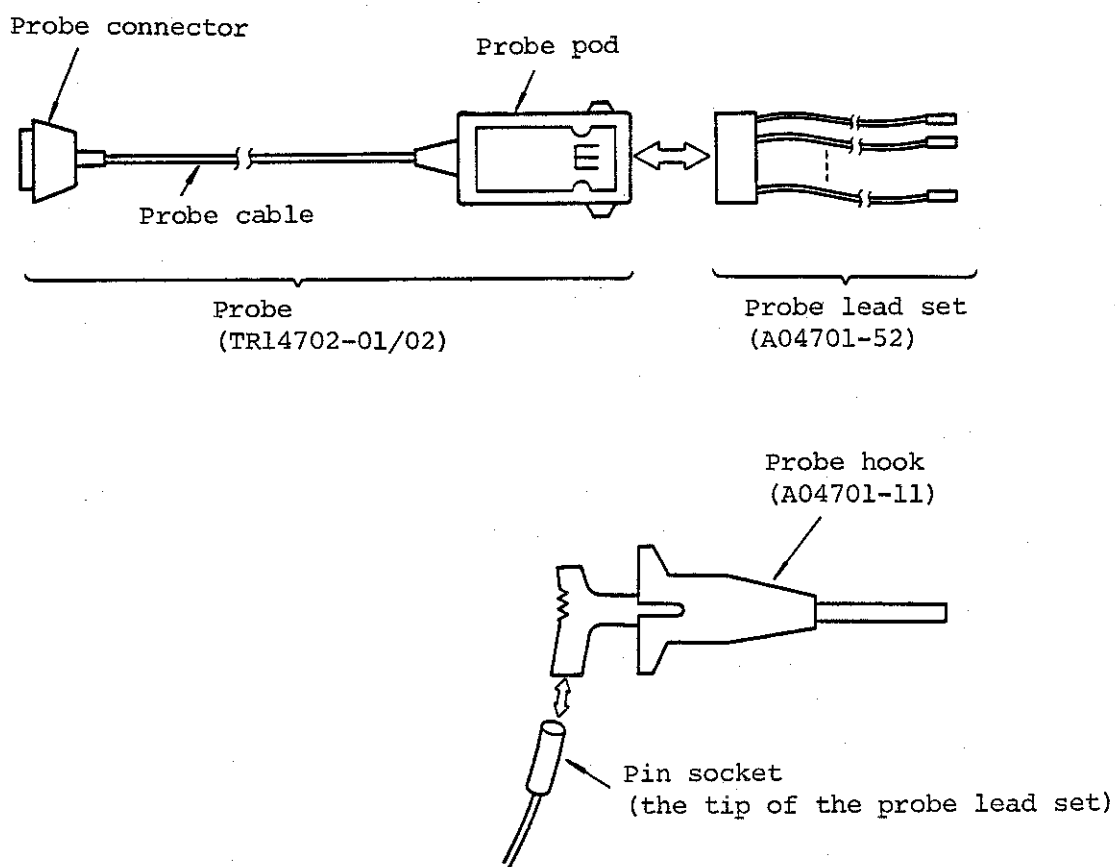

↔ indicates that the part can be freely attached and removed

Figure 2-5 Probe E/F Shape and Parts Names (Standard configuration)

TR47252
PERSONALITY KIT
INSTRUCTION MANUAL

2.3 CONNECTING PROBE AND THE SYSTEM UNDER TEST

First, connect the probe to the TR4725 main unit. Connect the probe E cable connector to the probe slot E ("E" is marked at the rear panel) and the probe F cable connector to the probe slot F after each probe connector is put through the cable holder at the left of the rear panel as shown in Figure 2-6.

CAUTION

Before connecting probe E/F, make sure to turn OFF the power of the main unit.

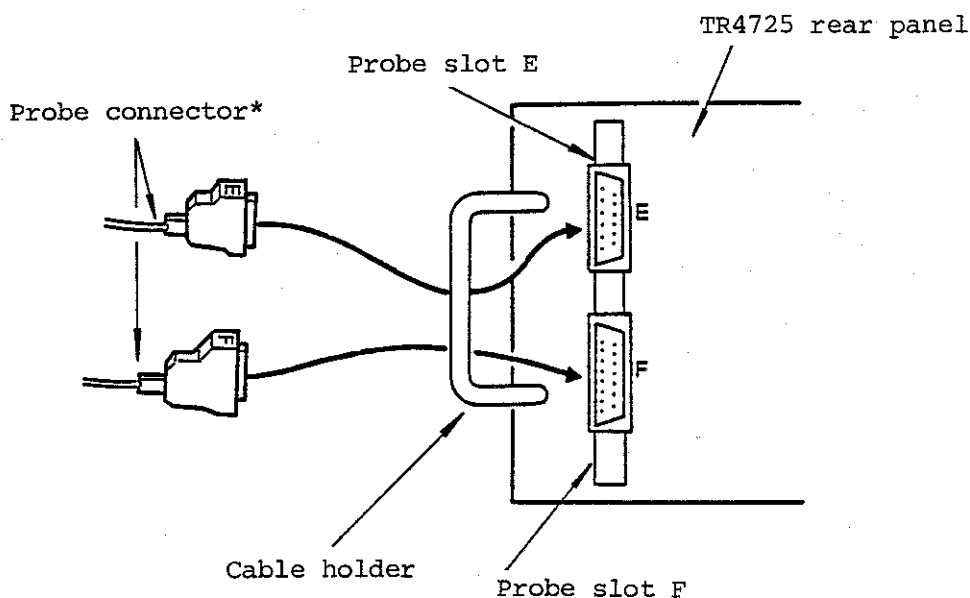

*: Insert the connector name plate E/F upward

Figure 2-6 Connecting Probe E/F to the TR4725 Main Unit

Next, connect probe to SUT. As a standard procedure, use the probe lead set (A04701-52) with pin socket to connect probe to SUT via probe hook (A04701-11; single hook). When the pin which is suitable for pin socket is found in SUT, direct connection with the pin socket is possible. The stock No. and size of the pin socket is as follows:

TR47252
PERSONALITY KIT
INSTRUCTION MANUAL

2.3 CONNECTING PROBE AND THE SYSTEM UNDER TEST

Manufacturer	Stock No.	Suitable size
AUGAT KK-JAPAN	LSG-2BG2-1	0.51mm ϕ ~ 0.76mm ϕ

If necessary, probe can be connected to the SUT by using other optional accessories. Instead of the standard probe hook, the probe hook with a double hook tip-pin (A04701-16; double hook) can be used. (Refer to Figure 2-7 (a).)

Use the probe lead set (A04701-51) when soldering is used instead of probe hook or pin socket for connection. In this case, the connection of eight channels can be performed in one procedure. (Refer to Figure 2-7 (b).)

The use of the DIP IC clip (A04702-30/40/48/64) makes the connecting with DIP IC easier. In this case, connect the pin socket to the pin of the clip. (Refer to Figure 2-7 (c).)

TR47252
PERSONALITY KIT
INSTRUCTION MANUAL

2.3 CONNECTING PROBE AND THE SYSTEM UNDER TEST

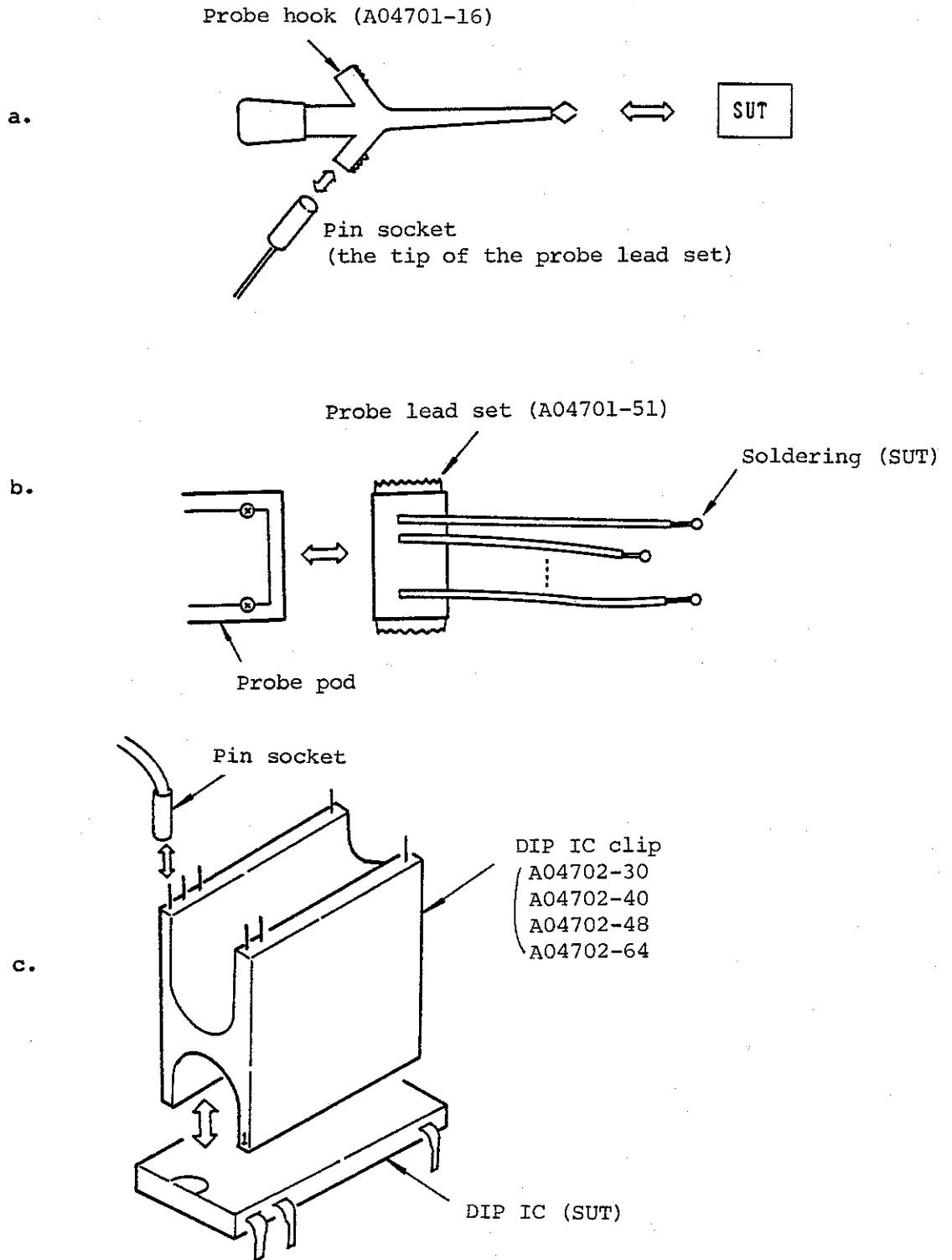

*: Match at pin 1 and then clip.

Figure 2-7 Connecting SUT with Optional Accessories

TR47252
PERSONALITY KIT
INSTRUCTION MANUAL

2.4 USE OF THE MICROPROCESSOR PROBE

2.4 USE OF THE MICROPROCESSOR PROBE

(1) Use of the microprocessor probe socket

Insert the removed target microprocessor into socket on the probe and lower the lever when connecting probe and the SUT with the DIP plug cable.

(2) Use of the status LEDs on the microprocessor probe

The following six status LEDs can be found on the microprocessor probe monitoring the state of the SUT microprocessor:

(Refer to the TR14725-20 External View at the end of this manual.)

- CLK : Lights when clock signal is applied.
- RESET : Lights when reset signal is applied.
- INTR : Lights when interrupt signal is applied.
- DTACK/VPA: Lights when DTACK or VPA signal is applied.
- BERR/HALT: Lights when BEEP or HALT signal is applied.
- BR/BGACK : Lights when BR or BGACK signal is applied.

TR47252
PERSONALITY KIT
INSTRUCTION MANUAL

2.5 LOADING THE SYSTEM SOFTWARE

2.5 LOADING THE SYSTEM SOFTWARE

The software (system software) which controls the operation of the personality kit is loaded from the system disk (P47252-001FJ) to the internal memory and executed. The built-in floppy disk drive is used for the system software loading.

Insert the system disk into the floppy disk drive, turn ON the POWER switch, and then loading starts automatically.

As shown in Figure 2-8, the following messages are displayed for loading:

```
TR47252
```

68000/68010 PK

System software loading in progress

Self-test ended

054725 V2.1 Copyright 1985 ADVANTEST CORPORATION

Figure 2-8 Screen Display for Loading

Loading requires approximately one minute. At the end of loading, CONFIGURATION (corresponds to CONFIG key) menu is displayed and the system enters into operation-enabled state as shown in Figure 2-9.

TR47252
PERSONALITY KIT
INSTRUCTION MANUAL

2.5 LOADING THE SYSTEM SOFTWARE

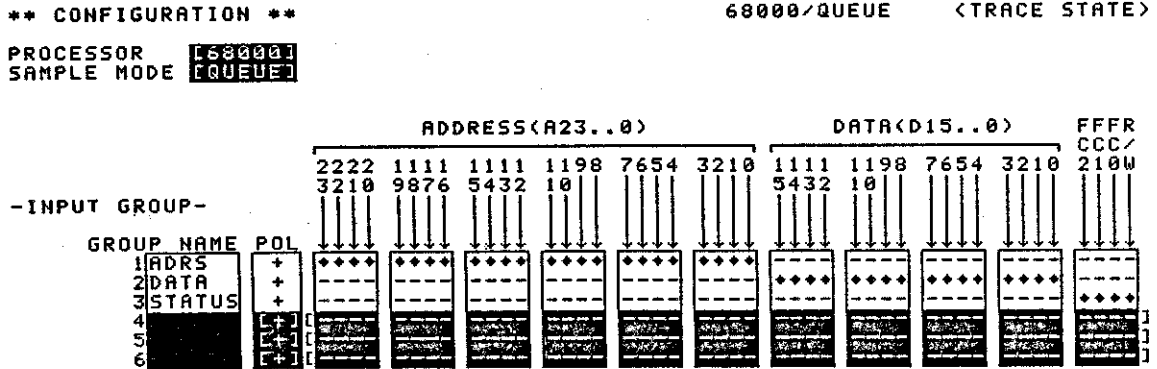

25-MAR-86 13:54

Figure 2-9 Screen Display at the End of Loading (CONFIG Menu Screen)

When the screen as shown in Figure 2-10 is displayed, it indicates that the internal clock is not functioning properly. Set the precise time by referring to Section 8.1 of the main unit instruction manual.

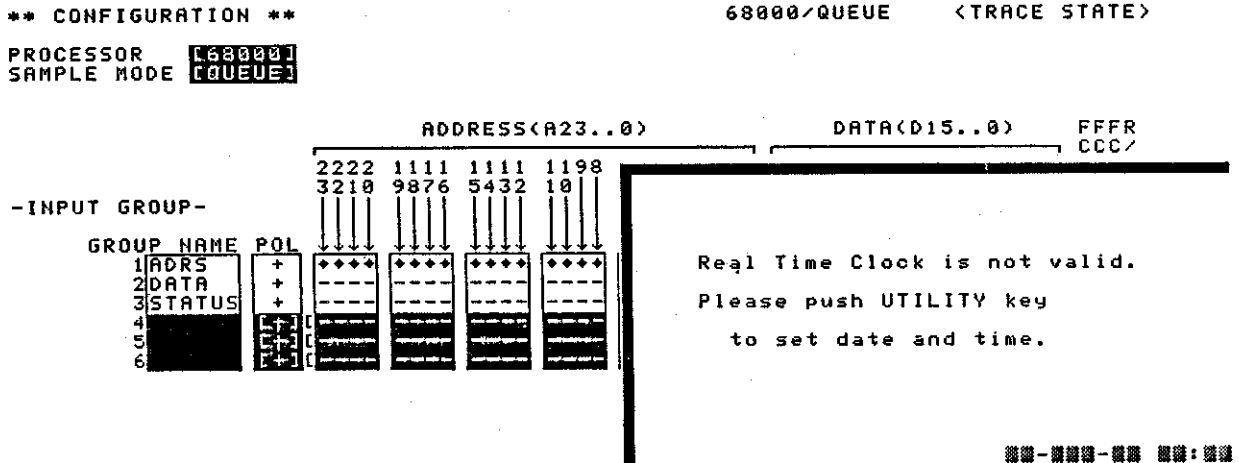

Figure 2-10 Screen Display Requesting Built-in Clock Setting

TR47252
PERSONALITY KIT
INSTRUCTION MANUAL

2.5 LOADING THE SYSTEM SOFTWARE

The display as shown in Figure 2-11 appears, requiring insertion of the system disk when the system disk is not inserted in the floppy disk drive when the POWER switch is turned ON. When the system disk is inserted, even when this display is shown, loading will start automatically. After the display of Figure 2-8, the display of either Figure 2-9 or Figure 2-10 appears and the system enters into operation-enabled state.

```
TR47252
68000/68010 PK

Please enter TR47252 68000/68010 PK System Software Package !
↓
Self-test ended

054725 U2.1 Copyright 1985 ADVANTEST CORPORATION
```

Figure 2-11 Screen Display Requesting System Disk Insertion

TR47252
PERSONALITY KIT
INSTRUCTION MANUAL

2.6 CRT DISPLAY FORMATS AND MEANINGS

Press and the display as shown in Figure 2-13 will appear. Analysis of the captured data is enabled on the DISPLAY menu screen.

```

** DISPLAY **                               68000/QUEUE   <TRACE STATE>
GROUP  [ADRS ] [DATA ] [STATUS] [HEX ] [HEX ] [HEX ] [HEX ] [HEX ]
RADIX  [HEX ] [HEX ] [HEX ] [HEX ] [HEX ] [HEX ] [HEX ] [HEX ]
[LN]  +-----+-----+-----+-----+-----+-----+-----+

```

25-MAR-86 14:01

Figure 2-13 DISPLAY Menu Screen

Basic measurement is executed in the State Only and S & T analyzers by interacting with the above three menu screens (configuration, trace specification, and display) and the menu screen by SYMDEF key (symbol definition).

Press on the lower center of the front panel twice. The file is read out and the data is displayed on the screen (refer to Figure 2-14).

```

** DISPLAY **   from F0:DISP.REG (68000,Q)   68000/QUEUE   <TRACE STATE>
GROUP  [ADRS ] [DATA ] [STATUS] [HEX ] [HEX ] [HEX ] [HEX ] [HEX ]
RADIX  [HEX ] [HEX ] [HEX ] [HEX ] [HEX ] [HEX ] [HEX ] [HEX ]
[LN]  +-----+-----+-----+-----+-----+-----+-----+
0000  000000  0000  D
0001  000002  1000  D
0002  000004  00F0  D
0003  000006  1000  D
0004  F01000  21FC  D
0005  F01002  00F0  D
0006  F01004  2000  D
0007  F01006  007C  D
0008  00007C  00F0  A
0009  00007E  2000  A
0010  F01008  243C  D
0011  F0100A  0000  D
0012  F0100C  0100  D
0013  F0100E  2F3C  D
0014  F01010  0000  D
0015  F01012  000A  D
0016  F01014  2F02  D

```

F0:DISP.REG, gotten

↑scroll 25-MAR-86 14:02

Figure 2-14 Sample Data for Explanation

TR47252
PERSONALITY KIT
INSTRUCTION MANUAL

2.6 CRT DISPLAY FORMATS AND MEANINGS

Each CRT display format contains a specific definition. The operation has been made easier by sustaining definition consistency through the whole displays.

- (1) "Normal display": Usually displayed by characters or diagrams in green; used for displaying fixed information such as header word or measured data.

This indication is equivalent to headers such as DISPLAY on the upper left of the screen or measured data (list) in the above sample data.

- (2) "Inverse display": Indicates inversed luminance of the character or diagram. This is called "menu item". The user can use this to set or revise data. [HEX] is equivalent to this display in the above sample data.
- (3) "Normal blink display": Blinks to display "normal display"; used to display the status of the error message, measurement or I/O execution. By pressing any numeric key (for instance, 0) when the display as shown in Figure 2-14, the message called "normal blink display" is displayed on the bottom line of the CRT display.
- (4) "Inverse blink display": Blinks to display "Inverse display", indicates the "menu item" that can be currently entered. The blinking portion, in particular, is called "input prompt". The display format of [ADRS] immediately after GET is equivalent to this.
- (5) "Half-tone display": Indicates the half luminance which is used for measurement execution or I/O operation. The "input prompt" cannot be moved to the "menu item" which is turned to half-tone display (the setting of data to the menu item becomes disabled).

Press on the lower center of the front panel twice, and the display as shown in Figure 2-15 will appear. The menu display (e.g. main menu) other than the smaller menu display newly appearing on the CRT display (e.g. sub-menu) is called "half-tone display". Pay attention when referencing the display of figures since the "half-tone display" cannot be printed on the screen which is output by a video plotter (as shown in Figure 2-15).

TR47252
PERSONALITY KIT
INSTRUCTION MANUAL

2.6 CRT DISPLAY FORMATS AND MEANINGS

** DISPLAY ** from F0:DISP.REG (68000,Q) 68000/QUEUE <TRACE STATE>

GROUP	ADRS	DATA	STATUS	CHEX	CHEX	CHEX	CHEX	CHEX
RADIX	HEX	HEX	HEX	HEX	HEX	HEX	HEX	HEX
LN								
0000	000000	0000	D					
0001	000002	1000	D					
0002	000004	00F0	D					
0003	000006	1000	D					
0004	F01000	21FC	D					
0005	F01002	00F0	D					
0006	F01004	2000	D					
0007	F01006	007C	D					
0008	00007C	00F0	A					
0009	00007E	2000	A					
0010	F01008	243C	D					
0011	F0100A	0000	D					
0012	F0100C	0100	D					
0013	F0100E	2F3C	D					
0014	F01010	0000	D					
0015	F01012	000A	D					
0016	F01014	2F02	D					

** FD OPERATION **

OPERATION [DIRECTORY] of [MENU]
DRIVE [F0#]

F0:___name___blks__attri__date_____
DISP.REG 54 DSP_5 01-FEB-86 11:42

25-MAR-86 14:05

Figure 2-15 FD Menu Screen

TR47252
PERSONALITY KIT
INSTRUCTION MANUAL





2.7 INPUTTING DATA TO MENU ITEMS

2.7 INPUTTING DATA TO MENU ITEMS

The menu display corresponding to keys of MENU and I/O key groups can be displayed by pressing the key accordingly.



More than one menu items are presented on the menu display. The menu display corresponding to the MENU key group is called main menu display. The menu display corresponding to the I/O key group is called sub-menu display. The sub-menu display can be called or deleted at any time to the main menu display (when deleting, press any key of the MENU key group or



). The main menu display becomes half-tone display when the sub-menu display is called. Try to enter keys to actually understand their functions. The four basic rules for inputting data to the menu items are as follows:

- The menu item for data inputting is displayed inversely.
- The menu item (input prompt) for inputting data (currently permitted) by pressing the ENTRY key is displayed by inverse blink display.
- Input prompt can be moved by     or .
- The menu item enclosed in brackets can be selected by the SELECT key.

- (1) The menu item enclosed in brackets:

For the menu item enclosed in brackets, data is input by pressing SELECT

( , ) key to select from the chain data group.

The data group is selected in due order with  key; in inverse order with  key. Pay attention that the same menu item of the selectable data group can be different according to the ambient conditions. The

selection range of the data group can be referenced beforehand with  (refer to item (1) of Section 2.6). No syntax error will occur with the data input by SELECT key, thus this method is adopted by the TR4725 as much as possible. The normal display enclosed in brackets are also menu items. However, data input is not allowed because of only one menu item selection. This inputting method is adopted for most of menu items is DISPLAY menu screen. Try to observe how the display can be changed for

the data group in the GROUP or RADIX menu item by pressing .



TR47252
PERSONALITY KIT
INSTRUCTION MANUAL

2.7 INPUTTING DATA TO MENU ITEMS

(2) The menu items not enclosed in brackets:

For menu items that are not enclosed in brackets, data can be input by pressing any ENTRY keys other than the SELECT key. These menu items are designed for defining GROUP, SYMBOL, and CODE names (these are for the state analysis section only) or calling/storing file name and require numeric values of binary, octal, decimal, and hexadecimal. The initial character (or digit) of each menu item becomes the input prompt when the

input prompt item is moved by     . Next, the system is set to NIBBLE mode by entering either  or input data of one character

(or one digit). When  or  is pressed, input prompt can shift one character (or one digit) at a time (LED of NIBBLE key is lit), NIBBLE mode is released and the input prompt is moved to the next menu item (menu item of the right on the same line or the left end on the next line). For the menu item such as the one selected by GET/SAVE key (requesting file name) which can only enter one character at a time, NIBBLE mode is automatically set and the LED of the key is lit.

No explanation of the menu display of SYMDEF (not used for timing only analyzer) or PROGRAM key that execute a line of the menu items is given in this section.

TR47252
PERSONALITY KIT
INSTRUCTION MANUAL

2.8 USE OF HELP KEY

2.8 USE OF HELP KEY

assists the user by providing useful information for operating this personality kit. It has two functions: HELP (menu item) and HELP (key).

HELP (menu item) displays the data input related information (an active-type of information which changes with the measuring conditions) to each menu item. For the menu item which uses the SELECT key, the selectable data group when / is pressed is displayed.

HELP (key) displays the key-related information (a static-type of information which does not change with the measuring conditions) which includes basically the key function summary, the summary of the related key functions, and the index to the instruction manual. The operating method for each function differs.

(1) HELP (menu item) function

This function is available whenever the data input to the menu item is possible (system disk is not necessarily required). When is pressed and then released, the HELP screen is displayed on the lower right or lower left of the CRT display avoiding the input prompt menu items. The examples are shown in Figures 2-16 and 2-17. The HELP screen can be deleted by pressing any key including the scroll knob. However, whichever key is pressed, its function remains valid (for instance: when the ENTRY key is pressed, data input is executed. Turning the scroll knob can delete HELP screen without affecting the main menu screen). Test the HELP function in DISPLAY menu screen.

TR47252
PERSONALITY KIT
INSTRUCTION MANUAL

2.8 USE OF HELP KEY

```

** DISPLAY **      from F0:DISP.REG (68000,Q)      68000/QUEUE      <TRACE STATE>
GROUP [ADRS ] [DATA ] [STATUS] [ ] [ ] [ ] [ ] [ ] [ ]
RADIX [HEX ] [HEX ] [HEX ] [HEX ] [HEX ] [HEX ] [HEX ] [HEX ] [HEX ]
[LN] +-----+-----+-----+-----+-----+-----+-----+-----+-----+
0000  000000  0000  D
0001  000002  1000  D
0002  000004  00F0  D
0003  000006  1000  D
0004  F01000  21FC  D
0005  F01002  00F0  D
0006  F01004  2000  D
0007  F01006  007C  D
0008  00007C  00F0  A
0009  00007E  2000  A
0010  F01008  243C  D
0011  F0100A  0000  D
0012  F0100C  0100  D
0013  F0100E  2F3C  D
0014  F01010  0000  D
0015  F01012  000A  D
0016  F01014  2F02  D

```

NEXT:→[DATA]→[STATUS]→
PREV:→[]→[STATUS]→

↑scroll 25-MAR-86 14:07

Figure 2-16 HELP (menu item) Function Display Example (1)

```

** TRACE SPECIFICATION **      68000/QUEUE      <TRACE S&T(S+T)>
[TRACE S&T(S+T)]_-----[TRIG1] disarms TRIG_T_-----QuickVIEW [OFF]
[ STORE1 = [1024] states DELAY = +0000
1
GROUP [ADRS ] [DATA ] [STATUS] [ ] [ ] [ ] [ ] [ ] [ ]
RADIX [HEX ] [HEX ] [CODE ] [HEX ] [HEX ] [HEX ] [ ]
ENBL1 [ ] [XXXXXX] [XXXX] [(abs) X]
TRIG1 [ ] [XXXXXX] [XXXX] [(abs) X]
[OR0] [ ] [ ] [ ] [ ] [ ] [ ] [ ] [ ]
DSBL1 [ ] [XXXXXX] [XXXX] [(abs) X]
L TRIG PASS = 001 TRIG OUT(SYNC) [OFF]

```

NEXT:→[ADRS]→[DATA]→
PREV:→[STATUS]→[DATA]→

CLOCK RATE [10ns]0
↑scroll 25-MAR-86 14:08

Figure 2-17 HELP (menu item) Function Display Example (2)

TR47252
PERSONALITY KIT
INSTRUCTION MANUAL

2.8 USE OF HELP KEY

(2) HELP (key) function

This function is available only when the system disk is installed in the floppy disk drive and the system is under the key entry enabled state. The HELP screen is displayed on the right or the left side of the CRT

avoiding the menu item of the input prompt when HIF is pressed along with other desired function key. The display examples are shown in Figures 2-18 and 2-19.

```

** DISPLAY **      from F0:DISP.REG (68000,Q)      68000/QUEUE      <TRACE S&T(S+T)>
GROUP  [ADRS] [DATA] [STATUS] [HEX] [HEX] [HEX] [HEX] [HEX]
RADIX  [HEX] [HEX] [HEX] [HEX] [HEX] [HEX] [HEX] [HEX]
-----+-----+-----+-----+-----+-----+-----+-----
[LN]  0000 000000 0000      D
0001 000002 1000      D
0002 000004 00F0      D
0003 000006 1000      D
0004 F01000 21FC      D
0005 F01002 00F0      D
0006 F01004 2000      D
0007 F01006 007C      D
0008 00007C 00F0      A
0009 00007E 2000      A
0010 F01008 243C      D
0011 F0100A 0000      D
0012 F0100C 0100      D
0013 F0100E 2F3C      D
0014 F01010 0000      D
0015 F01012 000A      D
0016 F01014 2F02      D

```

```

** HELP **  UTILITY
VERSION UP NEWS AVAILABLE IN NEXT PAGES

HELP information
not available until V2.0

↑scroll  25-MAR-86 14:09

```

Figure 2-18 HELP (key) Function Display Example (1)

```

** TRACE SPECIFICATION **      68000/QUEUE      <TRACE S&T(S+T)>
[TRACE S&T(S+T)]-----[TRIG1] disarms TRIG_T-----QuickVIEW [OFF]
[ STORE1 = [1024] states DELAY = #0000
|
| GROUP  [ADRS] [DATA] [STATUS] [HEX] [HEX] [HEX] [HEX]
| RADIX  [HEX] [HEX] [HEX] [HEX] [HEX] [HEX] [HEX]
|
** HELP **  DISPLAY
|
| HELP information
| not available until V2.0
|
| C) [OFF]
|
|-----|
| CLOCK RATE [10ns]
|
|-----|
|
|-----|

```

Figure 2-19 HELP (key) Function Display Example (2)

TR47252
PERSONALITY KIT
INSTRUCTION MANUAL

2.8 USE OF HELP KEY

When the scroll mark is displayed on the bottom line of the CRT, it indicates that the further data exist. The latest data can be displayed

by turning the scroll knob or pressing PAGE keys.

Pressing any key, other than the scroll knob, can delete the HELP (key) screen. However, the EDIT and ENTRY keys can only be used to delete the screen, and the original key function becomes invalid.

The information displayed by the HELP (key) function and the currently displayed menu screen are not directly relates. Data is read and displayed from the system disk onto the HELP (key) screen, so the system disk must be installed in the floppy disk drive. When the system disk is not installed and this function is attempted to activate, the message as shown in Figure 2-20 is displayed. Test this function.

```

** DISPLAY **   from F0:DISP.REG (68000.Q)       68000/QUEUE   <TRACE S&T(S+T)>
GROUP  [ADDRS] [DATA] [STATUS] [CHK] [CHK] [CHK] [CHK] [CHK]
RADIX  [HEX]  [HEX]  [HEX]  [HEX] [HEX] [HEX] [HEX] [HEX]
-----+-----+-----+-----+-----+-----+-----+-----+-----
[LN]  [ ] [ ] [ ] [ ] [ ] [ ] [ ] [ ]
0000  000000  0000  D
0001  000002  1000  D
0002  000004  00F0  D
0003  000006  1000  D
0004  F01000  21FC  D
0005  F01002  00F0  D
0006  F01004  2000  D
0007  F01006  007C  D
0008  00007C  00F0  A
0009  00007E  2000  A
0010  F01008  243C  D
0011  F0100A  0000  D
0012  F0100C  0100  D
0013  F0100E  2F3C  D
0014  F01010  0000  D
0015  F01012  000A  D
0016  F01014  2F02  D

```

```

** HELP **  DISPLAY

Please enter TR47252 68000/68010 PK
      system software package!

Push HELP key again.

25-MAR-86 14:12

```

Figure 2-20 Screen Requesting System Disk Insertion by the HELP (key) Function

Screens are configured from combination of main menu, sub-menu, HELP (menu item), and HELP (key) screens and the attached screen other than the main menu screen can be deleted completely by pressing .

TR47252
PERSONALITY KIT
INSTRUCTION MANUAL

2.9 USER DISK PREPARATION

2.9 USER DISK PREPARATION

The explanations of the previous sections are for actually operating the Personality Kit by its system disk, while this section deals with storing the measuring conditions, measured data, and programs on the user disk. The user disk is prepared by using the operation examples in Chapter 3. Disk formatting is required for preparing a user disk from a blank one. Remove the used system disk from the floppy disk drive and replace it with a blank disk.

Press and then four times, and the screen as shown in Figure 2-21 will appear.

```

** DISPLAY **   from F0:DISP.REG (68000,Q)       68000/QUEUE   <TRACE S&T(S+T)>
GROUP [ADRS ] [DATA ] [STATUS] [HEX ] [HEX ] [HEX ] [HEX ] [HEX ]
RADIX [HEX ] [HEX ] [HEX ] [HEX ] [HEX ] [HEX ] [HEX ]
-----+-----+-----+-----+-----+-----+-----+-----+
[LN] 0000 000000 0000 D
0001 000002 1000 D
0002 000004 00F0 D
0003 000006 1000 D
0004 F01000 21FC D
0005 F01002 00F0 D
0006 F01004 2000 D
0007 F01006 007C D
0008 00007C 00F0 A
0009 00007E 2000 A
0010 F01008 243C D
0011 F0100A 0000 D
0012 F0100C 0100 D
0013 F0100E 2F3C D
0014 F01010 0000 D
0015 F01012 000A D
0016 F01014 2F02 D

```

```

** FD OPERATION **
OPERATION [FORMAT ]
DRIVE [F0+]
DESCRIPTION [ ]

```

25-MAR-86 14:13

Figure 2-21 Disk Format

Next, press twice to move the input prompt to the menu item "DESCRIPTION" and input characters of less than 20 character long (For instance: "MY DISK"). Then, press . The screen will ask "FORMAT?". Press the green key on the bottom right corner of the front panel and then to start formatting. When the screen as shown in Figure 2-22 appears, it indicates the end of formatting. (The green key is the shift key, and "Y" is entered by the operations described above.)

TR47252
PERSONALITY KIT
INSTRUCTION MANUAL

2.9 USER DISK PREPARATION

```

** DISPLAY **   from F0:DISP.REG (68000,Q)   68000/QUEUE   <TRACE S&T(S+T)>
GROUP  [ADRS] [DATA] [STATUS] [HEX] [HEX] [HEX] [HEX] [HEX]
RADIX  [HEX] [HEX] [HEX] [HEX] [HEX] [HEX] [HEX] [HEX]
[LN]
0000  000000  0000  D
0001  000002  1000  D
0002  000004  00F0  D
0003  000006  1000  D
0004  F01000  21FC  D
0005  F01002  00F0  D
0006  F01004  2000  D
0007  F01006  007C  D
0008  00007C  00F0  A
0009  00007E  2000  A
0010  F01008  243C  D
0011  F0100A  0000  D
0012  F0100C  0100  D
0013  F0100E  2F3C  D
0014  F01010  0000  D
0015  F01012  000A  D
0016  F01014  2F02  D

```

```

** FD OPERATION **
OPERATION [LFORMAT]
DRIVE     [F0F]
DESCRIPTION
F0:-----
DISK ID : TR47252 USER DISK
DESCRIPTION : MY DISK
AVAILABLE AREA : 2530 blocks
USED AREA      :    2 blocks
BAD AREA       :    0 block
25-MAR-86 14:18

```

Figure 2-22 Display at the end of Disk Formatting

Press and then press twice, and the data that is currently displayed on the screen is written into the disk. When is pressed twice consecutively, the file names stored in the user disk is read. The file that was written just now should bear the file name DISP.S1 (the name is automatically named by the TR4725). Perform the following procedures to call the file. Press and turn the scroll knob clockwise, and the file bearing the DISP.S1 will appear in the file name menu item. Next, again press and the file read from the user disk is displayed on the CRT. The fact that the displayed data belongs to the file named DISP.S1 is displayed on the first line of the CRT.

To delete the file press and then press twice, and the command "PURGE" will appear. Move the input prompt to the menu item "NUMBER OF DELETED FILE" and set the numeric data of "01" with the SELECT key. Then press to start the execution of PURGE to delete the file. Any blank disk which is 3.5 inches, 80 tracks and dual-sided double density is applicable, no matter what brand. (For instance: the OM-D4440 model of SONY, or the ADVANTEST A09502 model with a set of ten disks).

MEMO



A large, empty rectangular area with rounded corners, enclosed by a thin black border, intended for writing the memo's content.

TR47252
PERSONALITY KIT
INSTRUCTION MANUAL

3.1 INTRODUCTION

3. OPERATION EXAMPLES

3.1 INTRODUCTION

This chapter is to help beginners when learning how to operate the Personality Kit to gain a better understanding of the probe by providing some measuring examples.

The detailed operating procedures are described in the main unit instruction manual from Chapters 4 to 6, and Chapter 4 of the PK instruction manual. It is not necessary to read through all these manuals from the beginning. However, it is recommended to reference the important portions of them after learning the use of the probe from the following examples.

The operating procedures of the TR4725 are based on the operating rule of consistency, and thus can be operated by analogy. The following examples contain, along with the contents of Chapters 4 to 6 of the main unit instruction manual, the contents of the relations of the individual functions described in the PK instruction manual Chapter 4. Again, emphasis is on actual operation while reading the examples.

TR47252
PERSONALITY KIT
INSTRUCTION MANUAL

3.2 SIMPLE EXAMPLES OF TIMING ANALYSIS

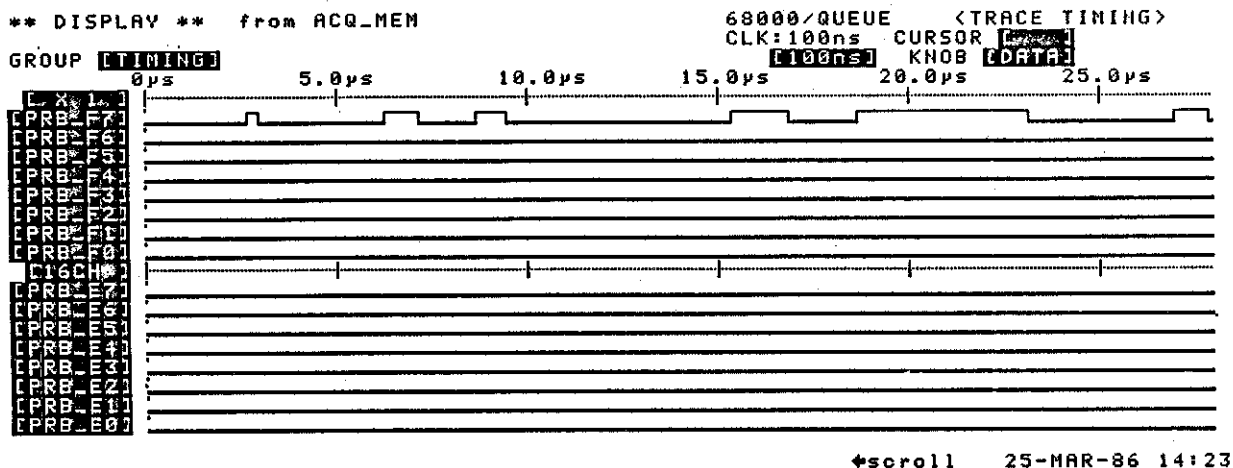

Figure 3-2 Timing Analysis Measurement Example (sampling clock: 100 ns)

What portion of the input signal starts to display is unpredictable no matter how many times is pressed.

Turn the scroll knob clockwise to move the data on the screen to the left; and vice versa. Turn the scroll knob fast and the data moves fast; slow

turning will also slow down the data changes. Next, press to move the input prompt to the menu item of [x 1] (time axis multiplier). The

time axis multiplier can be changed by pressing either or . x n expands the time axis; x 1/n contracts the time axis. All of the data contained in the memory (16 ch. x 2048 samples) attained at x 1/10 ratio is specified.

Next, press to move the input prompt to the menu item of [PRB_F7]. Enter "DATA" by using the character key of the ENTRY key group (refer to Figure 3-3).

Pay attention to the use of the shift key (the green key). When is pressed following the previous procedures, the label name [PRB_F7] is changed and displayed as [DATA] as shown in Figure. This function ensures that the data analysis can be performed with great ease.

TR47252
PERSONALITY KIT
INSTRUCTION MANUAL

3.2 SIMPLE EXAMPLES OF TIMING ANALYSIS

Refer to Section 4.2.3 for the screen that will appear next when ^{CONF} is pressed. Then, press ^{TRACE} and [→] to move the input prompt to TRIG_T. Next, press ¹ to set "1" to the equivalent position of "DATA" as shown in Figure 3-5. When ^{RM} is pressed, the screen as shown in Figure 3-6 will appear. After this, no matter how many times ^{RM} is pressed, the initial display remains at H level. This means that action is triggered (the trigger point indicates the initial data). (On the time axis, 0 ns is displayed).

Press ^{TRACE} again, and then press ^{RM} after setting 0 to "ENBL_T" and -0001 to "DELAY" as shown in Figure 3-7. At this point, the trigger point becomes clearer than before.

```

** TRACE SPECIFICATION **                               68000/QUEUE   <TRACE TIMING>
[TRACE TIMING]-----QuickVIEW [OFF]

  LABEL          ENBL_T  TRIG_T
DATA (PRB_F7)    X        X
PRB_F6 (PRB_F6)  X
PRB_F5 (PRB_F5)  X
PRB_F4 (PRB_F4)  X
PRB_F3 (PRB_F3)  X
PRB_F2 (PRB_F2)  X
PRB_F1 (PRB_F1)  X
PRB_F0 (PRB_F0)  X
PRB_E7 (PRB_E7)  X
PRB_E6 (PRB_E6)  X
PRB_E5 (PRB_E5)  X
PRB_E4 (PRB_E4)  X
PRB_E3 (PRB_E3)  X
PRB_E2 (PRB_E2)  X
PRB_E1 (PRB_E1)  X
PRB_E0 (PRB_E0)  X

CLOCK RATE [100ns]
DELAY = +0000 (0ps)

```

25-MAR-86 14:27

Figure 3-5 Trigger Pattern (TRIG_T) Setting Example

TR47252
PERSONALITY KIT
INSTRUCTION MANUAL

3.3 SIMPLE EXAMPLES OF STATE ANALYSIS

3.3 SIMPLE EXAMPLES OF STATE ANALYSIS

Connect the microprocessor probe to the main unit (refer to Section 2.3.1) and load the system software (refer to Section 2.5). Choose the desired processor when ** CONFIGURATION ** is displayed on the CRT. Next, press

(immediately after POWER ON, the measuring mode turns into the TRACE STATE).

Then press and the measured data as shown in Figure 3-8 appears (the data differs according to the system measured).

```

** DISPLAY **   from ACQ_MEM (68000,Q)           68000/QUEUE   <TRACE STATE>
GROUP [ADRS] [DATA] [LSTATUS] [CHEX] [CHEX] [CHEX] [CHEX] [CHEX]
RADIX [HEX] [HEX] [CHEX] [CHEX] [CHEX] [CHEX] [CHEX] [CHEX]
-----+-----+-----+-----+-----+-----+-----+-----
[LN]  F0100E  2F3C  D
0000  F01010  0000  D
0001  F01012  000A  D
0002  F01014  2F02  D
0003  000FFE  000A  A
0004  000FFC  0000  A
0005  F01016  4878  D
0006  000FFA  0100  A
0007  000FF8  0000  A
0008  F01018  0400  D
0009  000FF4  0000  A
0010  000FF6  0400  A
0011  F0101A  6100  D
0012  000FF0  00F0  A
0013  000FF2  101E  A
0014  F0101C  0008  D
0015  F01024  4E56  D
0016

```

↑scroll 25-MAR-86 14:35

Figure 3-8 State Analysis Measuring Example

The input prompt is moved to the menu item of [ADRS] on the first line on the left. Check if the contents of GROUP is changed when is pressed. ([ADRS] → [DATA] → [STATUS] → [] → [ADRS])

Then, press to move the input prompt to the menu item [HEX] and check if the contents of RADIX is changed by pressing . Next, press to move the input prompt to the RADIX selection menu item of [DATA] (currently in [HEX]). [DATA] is displayed in 68000/68010 mnemonic and

[MNEM] with [S-by-S] is displayed on the when is pressed. Then press to display the program.

Then, try to turn the scroll knob. Turn the scroll knob clockwise to scroll the data upwards, and turn the knob counterclockwise to scroll the

data downwards. Next, press the PAGE keys. What the scroll knob can move by a line can be moved by these keys ten lines, vertically.

TR47252
PERSONALITY KIT
INSTRUCTION MANUAL

3.3 SIMPLE EXAMPLES OF STATE ANALYSIS

Familiarize yourself with these operations and their effects on the DISPLAY screen by trying out all the key functions. Refer to Section 4.6.2 of the main unit instruction manual for the display formats and their meanings and the meaning of the menu items, and Section 4.6.3 for the use of the reference memory.

Next, press ^{TRACE} and press five times to move the input prompt to the menu item [ADRS] which is one element of TRIG1.

Input here the pattern of one data in [ADRS] as shown in Figure 3-8.

Then, press and the data with the pattern (called trigger) is moved to the upper most line of the measured data (refer to Figure 3-9). The same pattern remains unchanged on the upper most line no matter how many

times is pressed. Refer to Section 4.4.2 of the main unit

instruction manual for the screen which appears when ^{TRACE} is pressed.

```

** DISPLAY **   from RCQ_MEM (68000,0)           68000/QUEUE   <TRACE STATE>
GROUP [ADRS] [DATA] [STATUS] [HEX] [HEX]
RADIX [HEX] [MNM] [with [S-BY-S]]
-----
0000  F01016  PEA      000400.W      D
0001  000FFA  0100/super_data_ur   A
0002  000FF8  0000/super_data_ur   A
0003  F01018  ....                D
0004  000FF4  0000/super_data_ur   A
0005  000FF6  0400/super_data_ur   A
0006  F0101A  BSR.L  F01024        D
0007  000FF0  00F0/super_data_ur   A
0008  000FF2  101E/super_data_ur   A
0009  F0101C  ....                D
0010  F01024  LINK      A6,#0000    D
0011  F01026  ....                D
0012  000FEC  0000/super_data_ur   A
0013  000FEE  0FEC/super_data_ur   A
0014  F01028  MOVEM.L A34/D345,-(A7) D
0015  F0102A  ....                D
0016  000FEA  0400/super_data_ur   A
                                     +scroll   25-MAR-86 14:38

```

Figure 3-9 Measuring Example by Trigger Pattern Setting (State Analysis)

The measured data can be displayed not just by numeric values but also names. (For instance: the function name used for program creation). Therefore, it is necessary to define names (SYMBOL and CODE names). The

display which appears by pressing ^{SYM DEF} is used for definition. For details, refer to Sections 4.3.2 and 4.3.3 of the main unit instruction manual.

When all of the above operations are executed, the outline of the basic operation of the state analysis can be understood.

TR47252
PERSONALITY KIT
INSTRUCTION MANUAL

3.4 SIMPLE EXAMPLES OF S & T ANALYSIS

3.4 SIMPLE EXAMPLES OF S & T ANALYSIS

Connect the microprocessor probe and probe E/F to the main unit and execute loading of the system software.

Next, press ^{TRACE} to set the measuring mode to TRACE S&T (S→T) in which the state analysis and timing analysis sections operate simultaneously.

Execution starts when ^{RUN} is pressed. For the relations with the measured data, refer to Section 4.4.4 of the main unit instruction manual.

TR47252
PERSONALITY KIT
INSTRUCTION MANUAL

3.5 FLOPPY DISK APPLICATIONS

3.5 FLOPPY DISK APPLICATIONS

When the main unit POWER switch is turned OFF, all of the measured data and data set in the menu item displayed on the screen described respectively in Sections 3.2 to 3.4 are deleted. For re-use of these data, it is very convenient to store them on the floppy disk. The operations of the disk file of the TR4725 differ from those of the general-purpose type computers such as personal computers, and are rather simple.

Refer to Section 4.2.4 of the main unit instruction manual for file processing on the screen with ^{CONF}, Section 4.3.4 for file processing on the screen with ^{SYM DEF}, Section 4.4.5 for file processing on the screen with ^{TRACE}, and Sections 4.6.4 and 4.7.5 for file processing on the screen with ^{DISPLAY}.

TR47252
PERSONALITY KIT
INSTRUCTION MANUAL

3.6 USE OF QuickVIEW

3.6 USE OF QuickVIEW

The TR4725 has a new facility called QuickVIEW provided with the functions and ease of use of the oscilloscope for timing analysis.

The oscilloscope observes and measures the transitional condition of signals to be measured by setting the condition for attaining the desired screen and data by repeatedly operating the knobs of the trigger level or the key switches of time axis or input gain.

Though not exactly the same as the oscilloscope since the nature of the signals handled are different, QuickVIEW uses the scroll knob and provides the same ease of operation as the oscilloscope.

The operation procedures are simple. Press ^{TRACE} to move the input prompt to the menu item of QuickVIEW and set [ON] with ^{KEY}. Next, press ^{RM} to enter into QuickVIEW mode. The sampling clock is changed by simply turning the scroll knob and then the real time data can be observed.

Refer to Section 4.8 of the main unit instruction manual for details of the QuickVIEW facility.

TR47252
PERSONALITY KIT
INSTRUCTION MANUAL

3.7 EXAMPLES OF USING THE PROGRAMS

3.7 EXAMPLES OF USING THE PROGRAMS

After the operations described in the previous sections are learned, it is easy to create the program of measurement procedures by simple programming.

Programming starts immediately when PROGRAM is pressed.

Programs can be created by simply pressing REPT, FREQ, or DOWN. The

command that can be selected by REPT or FREQ has been made as similar as possible to the key operation. For instance, [TRACE] function is

equivalent to pressing TRACE. The created program is immediately

executable when AUTO is consecutively pressed twice. Pressing STOP

interrupts execution. For the operating procedures of the editor, refer to Section 6.2.1 of the main unit instruction Manual, and Section 6.2.2 for the type of commands that can be selected and their functions.

The created program is stored as a file (named as command file) and can be applied. For the application method, refer to Section 6.4 of the main unit instruction manual. Refer to Section 6.3 for the execution procedures of the command file.

The followings are explanations of some program examples. Try to create the same program for practice.

Figure 3-10 shows the program which executes the measurement by repetition (repeat function). The repeat function is a fixed function of conventional models of the logic analyzer. With the TR4725, all kinds of varieties can be developed. Figure 3-11 shows one example. The program as shown can display the acquired data within at five seconds most.

Run command is not necessarily required in the program. Figure 3-12 shows the program that only sets measuring conditions, which is convenient for setting measuring conditions to be used as a routine. Figure 3-13 shows the program that saves all kinds of measuring results in the system saved file after three measurements, by changing only the TRACE data.

Figure 3-14 shows the program that repeats the measurement ten times under the same measuring conditions.

TR47252
PERSONALITY KIT
INSTRUCTION MANUAL

3.7 EXAMPLES OF USING THE PROGRAMS

```
** PROGRAM **                                68000/QUEUE    <TRACE STATE>
LN__COMMAND-----COMMENT-----
00 [RUN]
01 [GOTO] LN[00]
02 END
```

25-MAR-86 15:13

Figure 3-10 Repeat Function Program 1

```
** PROGRAM **                                68000/QUEUE    <TRACE STATE>
LN__COMMAND-----COMMENT-----
00 [RUN]
01 [WAIT] 005 sec
02 [GOTO] LN[00]
03 END
```

25-MAR-86 15:14

Figure 3-11 Repeat Function Program 2

TR47252
PERSONALITY KIT
INSTRUCTION MANUAL

3.7 EXAMPLES OF USING THE PROGRAM

```
** PROGRAM **                               '68000/QUEUE   <TRACE STATE>
LN  _COMMAND-----COMMENT-----
00 [CONFIG]
01 [GET] [F0:] TEST1.CNF  GET
02 [TRACE]
03 [GET] [F0:] TEST1.TRC  GET
04 [SYMDEF]
05 [GET] [F0:] TEST1.SYM  GET
06  END
```

25-MAR-86 15:18

Figure 3-12 Program That Only Sets Measuring Conditions

```
** PROGRAM **                               '68000/QUEUE   <TRACE STATE>
LN  _COMMAND-----COMMENT-----
00 [CONFIG]
01 [GET] [F0:] TEST1.CNF  GET
02 [TRACE]
03 [GET] [F0:] TEST1.TRC  GET
04 [RUN]
05 [SAVE] [QUICK] [F0:] SAVE
06 [TRACE]
07 [GET] [F0:] TEST2.TRC  GET
08 [RUN]
09 [SAVE] [QUICK] [F0:] SAVE
10 [TRACE]
11 [GET] [F0:] TEST3.TRC  GET
12 [RUN]
13 [SAVE] [QUICK] [F0:] SAVE
14  END
```

25-MAR-86 15:41

Figure 3-13 Program Example -1

TR47252
PERSONALITY KIT
INSTRUCTION MANUAL

3.7 EXAMPLES OF USING THE PROGRAM

```
** PROGRAM **                                68000/QUEUE    <TRACE STATE>
LN  COMMAND-----COMMENT-----
00 [DEFINE] [I=] 00
01 [CONFIG]
02 [GET] [F0:] TEST1.CNF GET
03 [TRACE]
04 [GET] [F0:] TEST1.TRC GET
05 [RUN]
06 [SAVE] [QUICK] [F0:] SAVE
07 [COUNT+1] [I]
08 [IF] [I+] 10 THEN GOTO LN[05]
09 END
```

25-MAR-86 15:45

Figure 3-14 Program Example -2

MEMO



A large, empty rectangular area with rounded corners, enclosed by a thin black border. This area is intended for writing the content of the memo.

TR47252
PERSONALITY KIT
INSTRUCTION MANUAL

4.1 INTRODUCTION

4. PERSONALITY KIT PERFORMANCE CHARACTERISTICS

4.1 INTRODUCTION

The basic measurement operations are described in Chapter 4 of the main unit instruction manual. This chapter focuses on the performance characteristics of the Personality Kit. Refer to the related sections of the main unit instruction manual when reading this chapter. (For convenient reference, the section titles are identical.)

TR47252
PERSONALITY KIT
INSTRUCTION MANUAL

4.2 INPUT CHANNEL CONFIGURATION (CONFIG)

4.2 INPUT CHANNEL CONFIGURATION (CONFIG)

4.2.1 CONFIG Menu Screen for 68000/68010 Microprocessor

The CONFIG function determines how to configure the TR4725 input block on which the personality kit is installed. Section 2.3.1 describes the physical connection between the probe and SUT. This section describes the CONFIG function that determines how the analyzer performs level conversion of the electric signal input from the probes for sampling operation, and how it converts that signal into easy-to-handle logical data.

The CONFIG menu screen is divided into three types by measurement mode. (The measurement mode is set at the TRACE menu screen. For details, see Section 4.2.1 of the main unit instruction manual.

The timing analysis menu screen is independent of the personality kit. For how to handle the timing analyzer, refer to the TR4725 main unit instruction manual.

The state analysis menu screen is presented in Figure 4-1. This screen is used by both 68000 and 68010 microprocessors. The codes with the arrow sign stand for the name of the signal pins in 68000 and 68010. These microprocessors do not handle a signal named A0 (LSB of address bus), however, because there are odd-numbered addresses, the UDS and LDS signals are used to generate A0 inside the block for use. Therefore, odd-numbered addresses can be also used during SYMBOL and CODE definitions and the trace condition setting.

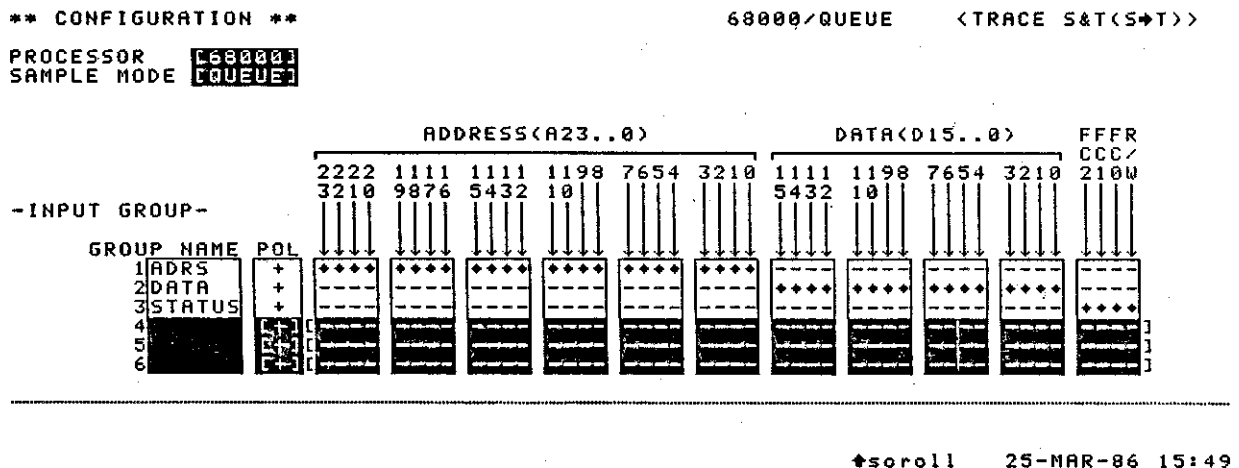

Figure 4-1 Menu Screen for State Analysis

TR47252
PERSONALITY KIT
INSTRUCTION MANUAL

4.2 INPUT CHANNEL CONFIGURATION (CONFIG)

The following item can be set at this menu screen:

- PROCESSOR: Selects either the 68000 or 68010 microprocessor.
- SAMPLE MODE: Selects either the QUEUE sample mode or the BUS sample mode.
The QUEUE sample mode captures data by synchronizing it with the 68000/68010 internal instruction queue. This mode does not capture data by the prefetched instructions which were not executed, therefore, it is ideal for software tracing. The BUS sample mode captures data output to the 68000/68010 buses as it is. This mode also captures the prefetched instructions which were not executed, and therefore, it is suitable for checking the relationships between the microprocessor and peripherals.
- POL: Specifies the polarization for signal capturing with + (positive) or - (negative).
- GROUP: Defines the unit in which several input channels are handled, as the input GROUP (termed GROUP hereafter). To define GROUP, specify the GROUP name having a maximum of six alphanumeric characters. Next, specify the input channel which belongs to the GROUP by entering the ♦ mark. Up to six GROUPS can generally be defined. However, three of them, [ADRS], [DATA] and [STATUS] have already been defined in the personality kit, and therefore, the user cannot change the names of those groups. The remaining three groups can be defined by the user. The input channel which has already been used may also be overlapped. The number (called a GROUP number, for instance, 1 for the GROUP number of GROUP [ADRS]) in the left side of the GROUP name is used to specify the GROUP name to be compared during program execution of the command [DEFINE] or [COMPARE_RANGE]. (See Section 4.1.2 in the main unit instruction manual.)

The selected PROCESSOR and SAMPLE MODE are always displayed in the center of the 1st line on the other menu screens. The defined GROUP may be used in the TRACE and DISPLAY menu screens.

TR47252
PERSONALITY KIT
INSTRUCTION MANUAL

4.3 SYMBOL AND CODE DEFINITIONS (SYMDEF)

4.3 SYMBOL AND CODE DEFINITIONS (SYMDEF)

This personality kit uses not only numeric values but also SYMBOL and CODE to set the trace condition (TRACE function) and to display and analyze the measured data (DISPLAY function). These are defined by the SYMDEF function.

SYMBOL is applicable to a GROUP having any number of channels. SYMBOL gives one SYMBOL name to numeric strings in a certain range. When used in accordance with the label or function name for program development, this SYMBOL improves the debugging efficiency.

CODE is applicable to a GROUP having 8 or fewer channels. It gives one CODE name to one numeric value, and therefore, the user can easily create the code tables.

For details of the SYMBOL and CODE definitions, see Section 4.3 in the main unit instruction manual.

4.3.1 CODE Table for 68000/68010

This personality kit has already been defined in the CODE tables for the GROUP [STATUS] (see Figure 4-2). The abbreviated codes used here are as follows:

U: User status
S: Supervisor status
DAT: Data area
PRG: Program area

** SYMBOL DEFINITION ** 68000/QUEUE <TRACE S&T(S+T)>

GROUP [STATUS] TYPE [CODE]
RADIX [HEX]

LN	NAME	VALUE	USE
000	U_DAT_WR	2	[+]
001	U_DAT_RD	3	[+]
002	U_PRG_WR	4	[+]
003	U_PRG_RD	5	[+]
004	S_DAT_WR	A	[+]
005	S_DAT_RD	B	[+]
006	S_PRG_WR	C	[+]
007	S_PRG_RD	D	[+]
008	INTA	F	[+]

pre-defined for 68000/68010 microprocessor
unchangeable

25-MAR-86 15:40

Figure 4-2 Defined CODE Table (68000/68010 status)

TR47252
PERSONALITY KIT
INSTRUCTION MANUAL

4.4 DISPLAY OF CAPTURED DATA IN STATE ANALYZER (DISPLAY)

4.4 DISPLAY OF CAPTURED DATA IN STATE ANALYZER (DISPLAY)

Figure 4-3 shows the measured data captured by the TR47252. For display format and menu screen setting, refer to Section 4.6.2 of the main unit instruction manual.

```

** DISPLAY **      from ACQ_MEM (68000,0)          68000/QUEUE    <TRACE STATE>
GROUP [ADRS] [DATA] [STATUS] [HEX] [HEX] [HEX] [HEX] [HEX]
RADIX [HEX] [HEX] [HEX] [HEX] [HEX] [HEX] [HEX] [HEX]
[LN]-----+-----+-----+-----+-----+-----+-----+-----
0000  000FAE  000A  A
0001  000FAC  0000  A
0002  F0106E  2F00  D
0003  000FAA  0002  A
0004  000FA8  0000  A
0005  F01070  61B2  D
0006  000FA6  0400  A
0007  000FA4  0000  A
0008  000FA0  00F0  A
0009  000FA2  1072  A
0010  F01024  4E56  D
0011  F01026  0000  D
0012  000F9C  0000  A
0013  000F9E  0FC4  A
0014  F01028  48E7  D
0015  F0102A  1C18  D
0016  000F9A  0400  A

```

↑scroll 25-MAR-86 15:53

Figure 4-3 Measured Data Display Example

4.4.1 QUEUE Sample Mode Display

Figure 4-4 shows an example in which the data captured with the QUEUE sample mode is displayed in mnemonic. This data is the same data as given in Figure 4-3.

The 68000/68010 microprocessors prefetch the instructions, therefore, the use timing of the bus during instruction fetching and its instruction execution is not generated repeatedly. The instruction which was fetched but not executed also presents.

The QUEUE sample mode samples data by synchronizing it with the 68000/68010 microprocessor internal queue. By this sampling operation, the analyzer captures instructions, displays its continuous timing, and but displays no instructions which were not executed. These operations enable easier-to-see displays, and thereby effective debugging. The part of "...." in the DATA displayed in mnemonic is defined as a part of the instruction code. In this case, the data for the "...." section is contained in the mnemonic (or operand) which is immediately above that "...." section. "." represents one hexadecimal digit data.

TR47252
PERSONALITY KIT
INSTRUCTION MANUAL

4.4 DISPLAY OF CAPTURED DATA IN STATE ANALYZER (DISPLAY)

```

** DISPLAY **   from ACQ_MEM (68000,Q)           68000/QUEUE   <TRACE STATE>
GROUP [ADRS] [LSTATUS] [LHEX]
RADIX [HEX] [MNMN] [with[S-by-S]] [CODE] [HEX]
-----
[LN] +-----+-----+-----+-----+
0000 000FAE 000A/super_data_ur S_DAT_WR
0001 000FAC 0000/super_data_ur S_DAT_WR
0002 F0106E MOVE.L A3,-(A7) S_PRG_RD
0003 000FAA 0002/super_data_ur S_DAT_WR
0004 000FA8 0000/super_data_ur S_DAT_WR
0005 F01070 BSR.S F01024 S_PRG_RD
0006 000FA6 0400/super_data_ur S_DAT_WR
0007 000FA4 0000/super_data_ur S_DAT_WR
0008 000FA0 00F0/super_data_ur S_DAT_WR
0009 000FA2 1072/super_data_ur S_DAT_WR
0010 F01024 LINK A6,#0000 S_PRG_RD
-----
0011 F01026 ..... S_DAT_WR
0012 000F9C 0000/super_data_ur S_DAT_WR
0013 000F9E 0FC4/super_data_ur S_DAT_WR
0014 F01028 MOVEM.L A34/D345,-(A7) S_PRG_RD
0015 F0102A ..... S_PRG_RD
0016 000F9A 0400/super_data_ur S_DAT_WR
                                     ↑scroll 25-MAR-86 15:54

```

Figure 4-4 S-by-S Display Example in QUEUE Sample Mode

The method for properly displaying the data which is captured by the analyzer is called the S-by-S (State-by-State) display mode. A mode excluding useless "...." sections in analysis operation from the above mode is called the PACKED display mode. Figure 4-4 shows the former display example, and Figure 4-5 shows the PACKED display by using the same data to be used in Figure 4-4.

```

** DISPLAY **   from ACQ_MEM (68000,Q)           68000/QUEUE   <TRACE STATE>
GROUP [ADRS] [LSTATUS] [LHEX]
RADIX [HEX] [MNMN] [with[PACKED]] [CODE] [HEX]
-----
[LN] +-----+-----+-----+-----+
0000 000FAE 000A/super_data_ur S_DAT_WR
0001 000FAC 0000/super_data_ur S_DAT_WR
0002 F0106E MOVE.L A3,-(A7) S_PRG_RD
0003 000FAA 0002/super_data_ur S_DAT_WR
0004 000FA8 0000/super_data_ur S_DAT_WR
0005 F01070 BSR.S F01024 S_PRG_RD
0006 000FA6 0400/super_data_ur S_DAT_WR
0007 000FA4 0000/super_data_ur S_DAT_WR
0008 000FA0 00F0/super_data_ur S_DAT_WR
0009 000FA2 1072/super_data_ur S_DAT_WR
0010 F01024 LINK A6,#0000 S_PRG_RD
-----
0012 000F9C 0000/super_data_ur S_DAT_WR
0013 000F9E 0FC4/super_data_ur S_DAT_WR
0014 F01028 MOVEM.L A34/D345,-(A7) S_PRG_RD
0016 000F9A 0400/super_data_ur S_DAT_WR
0017 000F98 0000/super_data_ur S_DAT_WR
0018 000F96 0400/super_data_ur S_DAT_WR
                                     ↑scroll 25-MAR-86 15:55

```

Figure 4-5 PACKED Display Example in QUEUE Sample Mode

TR47252
PERSONALITY KIT
INSTRUCTION MANUAL

4.4 DISPLAY OF CAPTURED DATA IN STATE ANALYZER (DISPLAY)

4.4.2 BUS Sample Mode Display

The example of the data captured in BUS sample mode in mnemonic is shown in Figure 4-6. This is the data measured under the same trace conditions as for Figures 4-3 and 4-5. (Only the CONFIG setting is different.)

The 68000/68010 microprocessor captures data which is accessed to the bus as in BUS sample mode. 68000/68010 microprocessor executes pre-fetch for the next instruction by the immediately previous instruction. Therefore, no consecutive operation of the bus along with the instruction code on the bus and its execution can occur. The part of ".." in the mnemonic displayed DATA is a part of the instruction code which indicates that it is a portion of the mnemonic (and operand) immediately before. "." indicates one digit of the hexadecimal.

```

** DISPLAY **      from ACQ_MEM (68000,B)          68000/BUS      <TRACE STATE>
GROUP [ADRS ] [DATA ] [STATUS] [HEX ]
RADIX [HEX ] [MNM ] [CODE ] [HEX ]
-----
0000 000FD6 000A/super_data_ur S_DAT_WR
0001 000FD4 0000/super_data_ur S_DAT_WR
0002 F01070 61B2/op_code S_PRG_RD
0003 000FD2 0019/super_data_ur S_DAT_WR
0004 000FD0 0000/super_data_ur S_DAT_WR
0005 F01072 4FEF/op_code S_PRG_RD
0006 000FCE 0400/super_data_ur S_DAT_WR
0007 000FCC 0000/super_data_ur S_DAT_WR
0008 000FC8 00F0/super_data_ur S_DAT_WR
0009 000FCA 1072/super_data_ur S_DAT_WR
0010 F01024 LINK A6,#0000 S_PRG_RD
-----
0011 F01026 ..... S_PRG_RD
0012 F01028 MOVEM.L A34/D345,-(A7) S_PRG_RD
0013 000FC4 0000/super_data_ur S_DAT_WR
0014 000FC6 0FEC/super_data_ur S_DAT_WR
0015 F0102A ..... S_PRG_RD
0016 F0102C MOVEA.L 0008(A6),A4 S_PRG_RD

```

*scroll 25-MAR-86 15:56

Figure 4-6 Display Example in BUS Sample Mode

TR47252
PERSONALITY KIT
INSTRUCTION MANUAL

4.4 DISPLAY OF CAPTURED DATA IN STATE ANALYZER (DISPLAY)

4.4.3 68000/68010 Disassembling Format

- (1) The mnemonic for the opcodes using Motorola's 68000/68010 standard assembly formats. (Data: M68000 microprocessor user's manual, forth issue, 1984)
- (2) All the numerics used in operands are displayed in hexadecimal numbers. Accordingly, no codes for indicating the numeric base are used.
- (3) The opcode which can handle different-sized operands is displayed with ".B" (byte), ".W" (word), or ".L" (long word) added. Note however that even if the opcode is equivalent to the one above, the opcode which takes CCR, SR, or USP as an operand needs no codes for the size specification.
- (4) Bcc, BRA, and BSR of the branch instruction group are displayed with ".S" (short) or ".L" (long) added according to their displacement sizes.
- (5) The immediate data is displayed with a # mark added. The data size of 3 or 4 bits is displayed in one hexadecimal digit in fixed length; 8 bits in 2 digits, 16 bits in 4 digits, and 32 bits in 8 digits.
- (6) The displacements other than for the branch instructions are displayed in the following way: the 8-bit displacement is displayed in two digits in hexadecimal numbers, and the 16-bit displacement in four digits in fixed lengths.
- (7) The operands (8 or 16-bits displacement) of the branch instructions (Bcc, BRA, BSR, DBcc) are displayed in six digits in hexadecimal number after being converted into the 24-bit absolute addresses.
- (8) When the jump instructions (JMP, JSR) and the memory operand are specified with absolute addresses, any instruction that takes the absolute address (16 or 32 bits) as an execution address is converted in 24-bit absolute address and then displayed with "__W" (word) or "__L" (long) added to indicate its size.
Example:
JMP hhhhhh__W (h stands for one hexadecimal digit)
JSR hhhhhh__L
- (9) When GROUP [ADRS] is displayed by SYMBOL, its address as an operand is displayed by SYMBOL as much as possible.
The display formats are:
SYMBOL name + hhhhhh (h stands for one hexadecimal digit)
SYMBOL name - hhhhhh

TR47252
PERSONALITY KIT
INSTRUCTION MANUAL

4.4 DISPLAY OF CAPTURED DATA IN STATE ANALYZER (DISPLAY)

- (10) The register list displayed by the MOVE instruction is as follows:
The register list is displayed in the order from address register (starting with A) to data register (starting with D). They are each delimited by / (slash). When there are four or more continuous register numbers, only the first and last numbers are displayed, and they are delimited by - (hyphen).
- (11) The names of the stack pointers (SP, USP, SSP) are indicated only in the instructions which need to indicate those names.
- (12) The ILLEGAL instruction (4AFC_H) is used as a formal opcode, however, the message, "hhhh/illegal" is displayed when any illegal or noninstallation instruction other than the above ILLEGAL instruction is detected.

MEMO



A large, empty rectangular area with rounded corners, enclosed by a thin black border, intended for writing the memo's content.

TR47252
PERSONALITY KIT
INSTRUCTION MANUAL

5.1 MICROPROCESSOR PROBE TEST

5. OPERATION CHECK

5.1 MICROPROCESSOR PROBE TEST

Since the Personality Kit uses connectors with many pins and cables for measurement, trouble such as imperfect contact occurs due to incorrect operation. A simple test is therefore designed to check the signal system operation. Perform the following procedures to check operation:

- (1) Mount the supplemented 68000/68010 probe test adapter on the PROBE TEST connector in the TR4725 rear panel.
- (2) When a DIP plug cable is used, directly connect the microprocessor probe to the probe test adapter via a 40-pin DIP IC package. (Refer to Figure 5-1.)

TR47252
PERSONALITY KIT
INSTRUCTION MANUAL

5.1 MICROPROCESSOR PROBE TEST

- (3) Set the measuring mode to TRACE STATE on the TRACE menu screen. Next, press .
- (4) Press on the CONFIG menu screen and then set the SAMPLE MODE menu item to [BUS].
- (5) Press to start checking.
- (6) Check if the display is the same as Figure 5-2; if it is, the operation is normal.

```

** DISPLAY **   from ACQ_MEM (68000,B)           68000/BUS      <TRACE STATE>

```

GROUP	ADRS	DATA	STATUS	CHEX	CHEX	CHEX	CHEX	CHEX
RADIX	CHEX	CHEX	CHEX	CHEX	CHEX	CHEX	CHEX	CHEX
0000	000000	0000	0					
0001	111110	1111	2					
0002	222222	2222	4					
0003	333332	3333	6					
0004	444444	4444	8					
0005	555554	5555	A					
0006	666666	6666	C					
0007	777776	7777	E					
0008	888888	8888	1					
0009	999998	9999	3					
0010	AAAAAA	AAAA	5					
0011	BBBBBA	BBBB	7					
0012	CCCCCC	CCCC	9					
0013	DDDDDC	DDDD	B					
0014	EEEEEE	EEEE	D					
0015	000000	0000	0					
0016	111110	1111	2					

↑scroll 25-MAR-86 16:05

Figure 5-2 Microprocessor Probe Test Result

TR47252
PERSONALITY KIT
INSTRUCTION MANUAL

5.2 DATA ACQUISITION PROBE E/F TEST

5.2 DATA ACQUISITION PROBE E/F TEST

The signal (500 kHz, TTL level pulse) testing the probe E/F outputs on the probe test adapter as shown in Figure 5-1. Perform the following procedures for testing:

- (1) Connect the probe test adapter to the PROBE TEST connector on the TR4725 rear panel.
- (2) Connect all the parts of the probe E/F input channel that needs to be tested to the test signal terminal via probe hooks.
- (3) Set the measuring mode to TRACE TIMING on the TRACE menu screen and then set the clock rate to 100 ns after pressing ^{DEFAULT} .
- (4) Press ^{MM} to start testing.
- (5) Check if the operation is normal by confirming that the display is the same as Figure 5-3. When error occurs with the measured data, contact your nearest ADVANTEST representative.

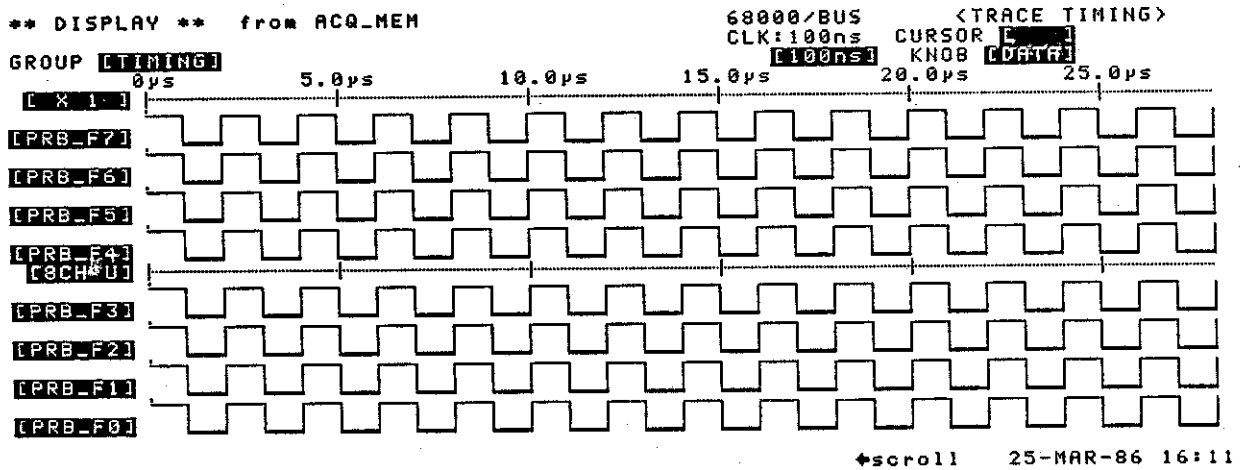

Figure 5-3 Probe E/F Test Result

TR47252
PERSONALITY KIT
INSTRUCTION MANUAL

6.1 STORAGE

6. EQUIPMENT STORAGE AND TRANSPORTATION PRECAUTIONS

6.1 STORAGE

The storage environment condition for the TR47252 Personality Kit is -10°C to $+60^{\circ}\text{C}$. When the probe is not used for a long time, place the kit in the Personality Kit storage case and keep in a dry place away from direct sunlight in particular, keep the board in the supplied conductive case). Be sure to store the floppy disk in an environment conditions of $+10^{\circ}\text{C}$ to $+60^{\circ}\text{C}$ (it is recommended to store the floppy disk separately from the Personality Kit storage case).

TR47252
PERSONALITY KIT
INSTRUCTION MANUAL

6.2 TRANSPORTATION

6.2 TRANSPORTATION

Use the packaging materials of first shipping when transporting the equipment. However, when the original packaging materials cannot be found, pack the equipment as follows:

- (1) Wrap the equipment with vinyl covers.
- (2) Wrap the equipment with 50 mm thick cushioning material and then place the wrapped equipment into a carton more than 5 mm thick.
- (3) After the equipment is wrapped with the cushioning material, put in the accessories, and then more cushioning material. Close the carton box and tie the box with packing ropes.

TR47252
PERSONALITY KIT
INSTRUCTION MANUAL

7.1 TR47252 SPECIFICATIONS

7. SPECIFICATIONS

7.1 TR47252 SPECIFICATIONS

Input Specifications

Applicable Microprocessor: MC68000L, MC68000CL, MC68000AL, MC68000G, MC68000CG (4/6/8/10/12.5 MHz), MC68010L, MC68010CL, MC68010G (8/10/12.5 MHz) of MOTOROLA Co.
EF68000C, EF68000CV (16 MHz) of TOMSON Co., or their equivalents.

Microprocessor clock frequency

: Depends on the system to be measured.

Input current

: -200 μ A max. (low level)

20 μ A max. (high level)

Microprocessor status display

: The LED on the microprocessor probe displays the status of CLK, RESET, INTR, DTACK/VPA, BEEP/HALT, and BR/BGACK.

Personality Kit operation mode

: 1. BUS sample mode

Captures data on 68000/68010 bus without modification.

2. QUEUE sample mode

Captures data on the bus in synchronous timing with the 68000/68010 internal instruction queue.

Logical polarity

: + or -

Input group

: Defined by the data input channel groups

Input group name

: An alphanumeric no more than 6 characters long

Input group number

: 6 max. among which 3 are already defined (ADRS, DATA, and STATUS)

Display Specifications

Display data source

: Acquisition memory, reference memory, and file

Display items

: 8 items max.

Input group display order: Capable of display by selecting the input group name in random order, repeated display of the same input group, and deletion of the specific input group display.

Display format

: Bus sample mode, S-by-S and PACKED displays in queue sample mode. State can be displayed in binary, octal, decimal, hexadecimal, symbol, coded ASCII code, 68000/68010 mnemonic (data only).

TR47252
PERSONALITY KIT
INSTRUCTION MANUAL

7.1 TR47252 SPECIFICATIONS

Transmission between memories

: The displayed data is transmitted to the reference memory. Data in reference memory and acquisition memory are displayed.

Data scroll

: Vertical scrolling by scroll knob. Page scroll key enables vertical scrolling in page units.

Specific display

: Trigger display for triggers. A memory boundary is displayed between trace windows.

Personality Kit configuration:

Item name	Model name	Q'ty	Remarks
Personality board		2	
Microprocessor probe	TR14725-20	1	
64-pin DIP clip cable	A04725-21	1	
64-pin DIP plug cable	A04725-22	1	
Probe test adapter		1	
64-pin DIP IC package		1	
System software package	P47252-001FJ	2	
Blank disk	MF-2DD	2	
Disk storage case		1	
Miscellaneous container		1	
Personality key storage case		1	
Instruction manual	E47252	1	

TR47252
PERSONALITY KIT
INSTRUCTION MANUAL

LIST OF FIGURES

LIST OF FIGURES

Figure No.	Title	Page
Figure 2-1	Personality Board Installation Method	2 - 2
Figure 2-2	Microprocessor Probe Shape and Parts Names	2 - 3
Figure 2-3	The Use of DIP Clip Cable	2 - 5
Figure 2-4	The Use of DIP Plug Cable	2 - 5
Figure 2-5	Probe E/F Shape and Parts Names (standard configuration)	2 - 6
Figure 2-6	Connecting Probe E/F and the TR47252 Main Unit	2 - 7
Figure 2-7	Connecting SUT with Optional Accessories	2 - 9
Figure 2-8	Screen Display for Loading	2 - 11
Figure 2-9	Screen Display at the End of Loading (<u>CONFIG</u> menu screen)	2 - 12
Figure 2-10	Screen Display Requesting Built-in Clock Setting	2 - 12
Figure 2-11	Screen Display Requesting System Disk Insertion	2 - 13
Figure 2-12	<u>TRACE</u> Menu Screen (<u>TRACE SPECIFICATION</u>)	2 - 14
Figure 2-13	<u>DISPLAY</u> Menu Screen	2 - 15
Figure 2-14	Sample Data for Explanation	2 - 15
Figure 2-15	<u>FD</u> Menu Screen	2 - 17
Figure 2-16	<u>HELP</u> (menu item) Function Display Example (1)	2 - 21
Figure 2-17	<u>HELP</u> (menu item) Function Display Example (2)	2 - 21
Figure 2-18	<u>HLEP</u> (key) Function Display Example (1)	2 - 22
Figure 2-19	<u>HELP</u> (key) Function Display Example (2)	2 - 22
Figure 2-20	Screen Requesting System Disk Insertion by the <u>HELP</u> (key) Function	2 - 23
Figure 2-21	Disk Format	2 - 24
Figure 2-22	Display at the end of Disk Formatting	2 - 25
Figure 3-1	Timing Analysis Measurement Example (sampling clock: 10 ns)	3 - 2
Figure 3-2	Timing Analysis Measurement Example (sampling clock: 100 ns)	3 - 3
Figure 3-3	Label Name Definition Example	3 - 4
Figure 3-4	Label Name Usage Example	3 - 4
Figure 3-5	Trigger Pattern (<u>TRIG__T</u>) Setting Example	3 - 5
Figure 3-6	Measuring Example with Trigger Pattern Setting	3 - 6
Figure 3-7	Delay Usage Example	3 - 6
Figure 3-8	State Analysis Measuring Example	3 - 7
Figure 3-9	Measuring Example by Trigger Pattern Setting (State Analysis)	3 - 8
Figure 3-10	Repeat Function Program 1	3 - 13
Figure 3-11	Repeat Function Program 2	3 - 13
Figure 3-12	Program That Only Sets Measuring Conditions	3 - 14
Figure 3-13	Program Example -1	3 - 14
Figure 3-14	Program Example -2	3 - 15
Figure 4-1	Menu Screen for State Analysis	4 - 2

TR47252
PERSONALITY KIT
INSTRUCTION MANUAL

LIST OF FIGURES

LIST OF FIGURES

<u>Figure No.</u>	<u>Title</u>	<u>Page</u>
Figure 4-2	Defined <u>CODE</u> Table (68000/68010 status)	4 - 4
Figure 4-3	Measured Data Display Example	4 - 5
Figure 4-4	S-by-S Display Example in QUEUE Sample Mode	4 - 6
Figure 4-5	PACKED Display Example in QUEUE Sample Mode	4 - 6
Figure 4-6	Display Example in BUS Sample Mode	4 - 7
Figure 5-1	Probe Test Connection	5 - 2
Figure 5-2	Microprocessor Probe Test Result	5 - 3
Figure 5-3	Probe E/F Test Result	5 - 4

TR47252
PERSONALITY KIT
INSTRUCTION MANUAL

LIST OF TABLES

LIST OF TABLES

<u>Table No.</u>	<u>Title</u>	<u>Page</u>
------------------	--------------	-------------

(No table numbers are assigned in this manual.)

TR47252
PERSONALITY KIT
INSTRUCTION MANUAL

LIST OF EXAMPLES

LIST OF EXAMPLES

<u>Example No.</u>	<u>Title</u>	<u>Page</u>
--------------------	--------------	-------------

(No example numbers are assigned in this manual.)

TR47252
PERSONALITY KIT
INSTRUCTION MANUAL

ALPHABETICAL INDEX

ALPHABETICAL INDEX

[B]		[S]	
BUS sample mode	4 - 7	S-by-S (State-by-State)	
		display mode	4 - 6
[C]		system software loading	2 - 11
CODE table	4 - 4	system under test (SUT)	2 - 3
		68000/68010 selection	4 - 3
[D]			
data acquisition probe	2 - 6		
DIP clip cable	2 - 5		
DIP IC clip	2 - 8		
DIP plug cable	2 - 5		
disassembling format	4 - 8		
[H]			
half-tone display	2 - 16		
HELP (key) function	2 - 22		
HELP (menu item) function	2 - 20		
[I]			
input prompt	2 - 18		
inverse blink display	2 - 16		
inverse display	2 - 16		
[M]			
microprocessor probe	2 - 3		
microprocessor			
status indicator	2 - 10		
[N]			
NIBBLE mode	2 - 19		
normal blink display	2 - 16		
normal display	2 - 16		
[P]			
PACKED display mode	4 - 6		
personality board	2 - 2		
pin socket	2 - 7		
probe hook	2 - 8		
probe lead set	2 - 7		
probe slot	2 - 7		
[Q]			
QUEUE sample mode	4 - 5		
[R]			
reference processor socket ...	2 - 10		

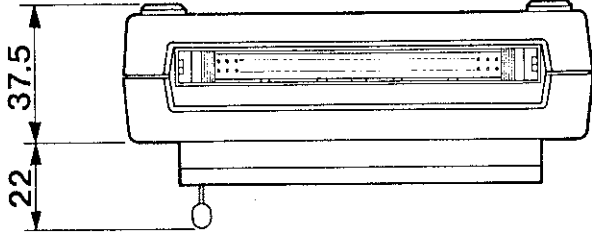

FRONT VIEW

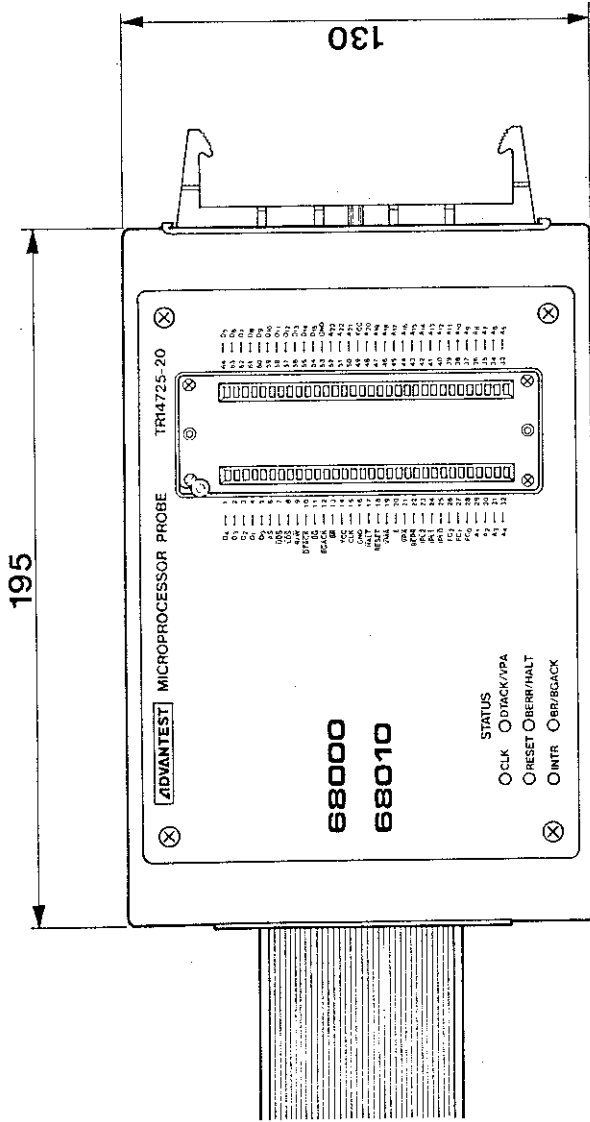

TOP VIEW

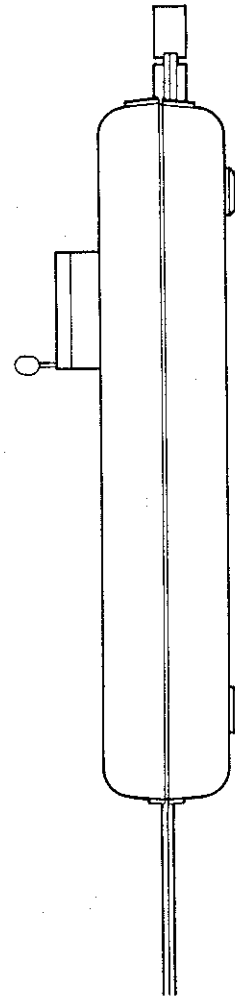

SIDE VIEW

TR14725-20
 EXTERNAL VIEW

IMPORTANT INFORMATION FOR ADVANTEST SOFTWARE

PLEASE READ CAREFULLY: This is an important notice for the software defined herein. Computer programs including any additions, modifications and updates thereof, operation manuals, and related materials provided by Advantest (hereafter referred to as "SOFTWARE"), included in or used with hardware produced by Advantest (hereafter referred to as "PRODUCTS").

SOFTWARE License

All rights in and to the SOFTWARE (including, but not limited to, copyright) shall be and remain vested in Advantest. Advantest hereby grants you a license to use the SOFTWARE only on or with Advantest PRODUCTS.

Restrictions

- (1) You may not use the SOFTWARE for any purpose other than for the use of the PRODUCTS.
- (2) You may not copy, modify, or change, all or any part of, the SOFTWARE without permission from Advantest.
- (3) You may not reverse engineer, de-compile, or disassemble, all or any part of, the SOFTWARE.

Liability

Advantest shall have no liability (1) for any PRODUCT failures, which may arise out of any misuse (misuse is deemed to be use of the SOFTWARE for purposes other than its intended use) of the SOFTWARE. (2) For any dispute between you and any third party for any reason whatsoever including, but not limited to, infringement of intellectual property rights.

LIMITED WARRANTY

1. Unless otherwise specifically agreed by Seller and Purchaser in writing, Advantest will warrant to the Purchaser that during the Warranty Period this Product (other than consumables included in the Product) will be free from defects in material and workmanship and shall conform to the specifications set forth in this Operation Manual.
2. The warranty period for the Product (the "Warranty Period") will be a period of one year commencing on the delivery date of the Product.
3. If the Product is found to be defective during the Warranty Period, Advantest will, at its option and in its sole and absolute discretion, either (a) repair the defective Product or part or component thereof or (b) replace the defective Product or part or component thereof, in either case at Advantest's sole cost and expense.
4. This limited warranty will not apply to defects or damage to the Product or any part or component thereof resulting from any of the following:
 - (a) any modifications, maintenance or repairs other than modifications, maintenance or repairs (i) performed by Advantest or (ii) specifically recommended or authorized by Advantest and performed in accordance with Advantest's instructions;
 - (b) any improper or inadequate handling, carriage or storage of the Product by the Purchaser or any third party (other than Advantest or its agents);
 - (c) use of the Product under operating conditions or environments different than those specified in the Operation Manual or recommended by Advantest, including, without limitation, (i) instances where the Product has been subjected to physical stress or electrical voltage exceeding the permissible range and (ii) instances where the corrosion of electrical circuits or other deterioration was accelerated by exposure to corrosive gases or dusty environments;
 - (d) use of the Product in connection with software, interfaces, products or parts other than software, interfaces, products or parts supplied or recommended by Advantest;
 - (e) incorporation in the Product of any parts or components (i) provided by Purchaser or (ii) provided by a third party at the request or direction of Purchaser or due to specifications or designs supplied by Purchaser (including, without limitation, any degradation in performance of such parts or components);
 - (f) Advantest's incorporation or use of any specifications or designs supplied by Purchaser;
 - (g) the occurrence of an event of force majeure, including, without limitation, fire, explosion, geological change, storm, flood, earthquake, tidal wave, lightning or act of war; or
 - (h) any negligent act or omission of the Purchaser or any third party other than Advantest.
5. **EXCEPT TO THE EXTENT EXPRESSLY PROVIDED HEREIN, ADVANTEST HEREBY EXPRESSLY DISCLAIMS, AND THE PURCHASER HEREBY WAIVES, ALL WARRANTIES, WHETHER EXPRESS OR IMPLIED, STATUTORY OR OTHERWISE, INCLUDING, WITHOUT LIMITATION, (A) ANY WARRANTY OF MERCHANTABILITY OR FITNESS FOR A PARTICULAR PURPOSE AND (B) ANY WARRANTY OR REPRESENTATION AS TO THE VALIDITY, SCOPE, EFFECTIVENESS OR USEFULNESS OF ANY TECHNOLOGY OR ANY INVENTION.**
6. **THE REMEDY SET FORTH HEREIN SHALL BE THE SOLE AND EXCLUSIVE REMEDY OF THE PURCHASER FOR BREACH OF WARRANTY WITH RESPECT TO THE PRODUCT.**
7. **ADVANTEST WILL NOT HAVE ANY LIABILITY TO THE PURCHASER FOR ANY INDIRECT, INCIDENTAL, SPECIAL, CONSEQUENTIAL OR PUNITIVE DAMAGES, INCLUDING, WITHOUT LIMITATION, LOSS OF ANTICIPATED PROFITS OR REVENUES, IN ANY AND ALL CIRCUMSTANCES, EVEN IF ADVANTEST HAS BEEN ADVISED OF THE POSSIBILITY OF SUCH DAMAGES AND WHETHER ARISING OUT OF BREACH OF CONTRACT, WARRANTY, TORT (INCLUDING, WITHOUT LIMITATION, NEGLIGENCE), STRICT LIABILITY, INDEMNITY, CONTRIBUTION OR OTHERWISE. TORT (INCLUDING, WITHOUT LIMITATION, NEGLIGENCE), STRICT LIABILITY, INDEMNITY, CONTRIBUTION OR OTHERWISE.**
8. **OTHER THAN THE REMEDY FOR THE BREACH OF WARRANTY SET FORTH HEREIN, ADVANTEST SHALL NOT BE LIABLE FOR, AND HEREBY DISCLAIMS TO THE FULLEST EXTENT PERMITTED BY LAW ANY LIABILITY FOR, DAMAGES FOR PRODUCT FAILURE OR DEFECT, WHETHER ARISING OUT OF BREACH OF CONTRACT, TORT (INCLUDING, WITHOUT LIMITATION, NEGLIGENCE), STRICT LIABILITY, INDEMNITY, CONTRIBUTION OR OTHERWISE.**

CUSTOMER SERVICE DESCRIPTION

In order to maintain safe and trouble-free operation of the Product and to prevent the incurrence of unnecessary costs and expenses, Advantest recommends a regular preventive maintenance program under its maintenance agreement.

Advantest's maintenance agreement provides the Purchaser on-site and off-site maintenance, parts, maintenance machinery, regular inspections, and telephone support and will last a maximum of ten years from the date the delivery of the Product. For specific details of the services provided under the maintenance agreement, please contact the nearest Advantest office listed at the end of this Operation Manual or Advantest's sales representatives.

Some of the components and parts of this Product have a limited operating life (such as, electrical and mechanical parts, fan motors, unit power supply, etc.). Accordingly, these components and parts will have to be replaced on a periodic basis. If the operating life of a component or part has expired and such component or part has not been replaced, there is a possibility that the Product will not perform properly. Additionally, if the operating life of a component or part has expired and continued use of such component or part damages the Product, the Product may not be repairable. Please contact the nearest Advantest office listed at the end of this Operation Manual or Advantest's sales representatives to determine the operating life of a specific component or part, as the operating life may vary depending on various factors such as operating condition and usage environment.

SALES & SUPPORT OFFICES

Advantest Korea Co., Ltd.

22BF, Kyobo KangNam Tower,
1303-22, Seocho-Dong, Seocho-Ku, Seoul #137-070, Korea
Phone: +82-2-532-7071
Fax: +82-2-532-7132

Advantest (Suzhou) Co., Ltd.

Shanghai Branch Office:
Bldg. 6D, NO.1188 Gumei Road, Shanghai, China 201102 P.R.C.
Phone: +86-21-6485-2725
Fax: +86-21-6485-2726

Shanghai Branch Office:
406/F, Ying Building, Quantum Plaza, No. 23 Zhi Chun Road,
Hai Dian District, Beijing,
China 100083
Phone: +86-10-8235-3377
Fax: +86-10-8235-6717

Advantest (Singapore) Pte. Ltd.

438A Alexandra Road, #08-03/06
Alexandra Technopark Singapore 119967
Phone: +65-6274-3100
Fax: +65-6274-4055

Advantest America, Inc.

3201 Scott Boulevard, Suite, Santa Clara, CA 95054, U.S.A
Phone: +1-408-988-7700
Fax: +1-408-987-0691

ROHDE & SCHWARZ Europe GmbH

Mühldorfstraße 15 D-81671 München, Germany
(P.O.B. 80 14 60 D-81614 München, Germany)
Phone: +49-89-4129-13711
Fax: +49-89-4129-13723

ADVANTEST®

<http://www.advantest.co.jp>